

# Meridian Digital Telephones

M3901  
M3902  
M3903  
M3904

User Guide





<b>M3900 Series Meridian Digital Telephone</b>	<b>1</b>
M3901 .....	1
M3902 .....	2
M3903 .....	3
M3904 .....	4
<b>Your Telephone's Controls</b>	<b>5</b>
<b>Terms you should know</b>	<b>8</b>
<b>Your telephone call features</b>	<b>10</b>
Use handsfree calling (M3902, M3903, and M3904) .....	10
Activate/deactivate Group listening .....	12
Use the Redial feature .....	14
<b>Make a call</b>	<b>15</b>
Make a call while on-hook .....	16
Auto Dial .....	16
Ring Again (M3902) .....	17
Ring Again (M3903 and M3904) .....	18
Redial last number called .....	19
Use Speed Call (M3902) .....	20
Use Speed Call (M3903 and M3904) .....	21
Make a System Speed Call .....	22
Use Hot Line .....	22
Make an Intercom call .....	23
<b>Answer a call</b>	<b>24</b>
<b>While on an active call</b>	<b>25</b>
Place a call on Hold .....	25
Transfer a call (M3902) .....	25
Transfer a call (M3903 and M3904) .....	26
Use Timed Reminder Recall .....	27
Use Attendant Recall .....	28
Use Call Park (M3902) .....	28

Use Call Park (M3903 and M3904) .....	30
Calling Party Number (M3902) .....	33
Calling Party Number/Charge Account (M3903 and M3904) .....	33
Display incoming calls .....	34
Trace a Malicious call .....	35

## **Incoming calls** **36**

---

Activate Automatic Answerback .....	36
Use Call Pickup .....	37
Use Call Waiting .....	38

## **While you are away from your desk** **39**

---

Forward calls (M3902) .....	39
Forward calls (M3903 and M3904) .....	40
Forward internal calls only .....	41
Use Remote Call Forward .....	42

## **Secure your telephone** **44**

---

## **Talk with more than one person** **45**

---

Set up a Conference call (M3902) .....	45
Set up a Conference call (M3903 and M3904) .....	46
Join a call (M3902) .....	47
Join a call (M3903 and M3904) .....	47
Selectable Conferee Display and Disconnect .....	48
Use Group Call .....	49

## **Work without interruption** **51**

---

Activate Make Set Busy .....	51
------------------------------	----

## **Additional Call Features** **52**

---

Auto Dial Transfer Feature .....	52
Use the buzz signal .....	52
Call Page to make an announcement .....	53
Centrex/Exchange Switch Hook Flash .....	53
Charge or Force Charge a call (M3902) .....	54
Charge or Force Charge a call (M3903 and M3904) .....	56

Enhanced Override Feature .....	58
Forced Camp-on .....	59
Station Camp-on .....	60
Override Feature .....	61
Privacy Release .....	62
Radio Paging .....	63
Voice Call .....	65
Use the Voice Messaging control screens .....	65

## **Hospitality features** **67**

---

Automatic Wake-Up .....	67
Message Registration .....	69
Maid Identification .....	70
Room Status .....	71

## **Meridian SL-100 CLASS Features** **72**

---

Anonymous Caller Rejection .....	72
Automatic Callback .....	73
Automatic Recall .....	74
Customer Originated Trace .....	75
Calling Name and Number Delivery Blocking .....	76
Selective Call Forward .....	76

## **Telephone display** **77**

---

M3902 display .....	77
M3903 display .....	77
M3904 display .....	78

## **Options List** **79**

---

Select a language .....	80
Change a Feature Key label (M3902) .....	80
Change a Feature Key label (M3903 and M3904) .....	82
Adjust Screen contrast .....	84
Adjust volume .....	84
Choose Ring type .....	85
Select Call Log options .....	85
Use Live dial pad .....	86

Select Preferred name match .....	86
Set up area code .....	86
Enable Call timer .....	87
Select Date/time format .....	87
Enable Key click .....	87
Use Headset port on call .....	88
Activate Headset port external alerter .....	88
Use Call indicator light .....	88
Set On-hook default path .....	89
Display diagnostics .....	89
Activate Group Listening .....	90

## **Call Log and Personal Directory display and navigation**

**91**

M3903 Call Log display and navigation .....	91
Access your Callers List or Redial List (M3903) .....	91
M3904 Personal Directory and Call Log display and navigation .....	92
Access your Personal Directory, Callers List, or Redial List (M3904) .....	93
Call Log and Personal Directory password protection (M3903 and M3904) .....	94

## **Call Log**

**97**

Access and use the Callers List (M3903) .....	97
Access and use the Callers List (M3904) .....	98

## **Redial List**

**100**

Access and use the Redial List (M3903) .....	100
Access and use the Redial List (M3904) .....	101

## **Access and use the Personal Directory** **102**

---

Access the Personal Directory .....	102
Add a Personal Directory entry .....	102
Add an incoming call .....	104
Add an outgoing call .....	105
Delete or edit a Personal Directory entry .....	106
Delete your Personal Directory .....	107
Use the Personal Directory to make a call .....	107
Use Card View .....	108
Search for an entry .....	109
Copy a number from the Redial List .....	109

## **Set-to-Set Messaging** **111**

---

## **Corporate Directory** **114**

---

## **Virtual Office** **117**

---

## **M3901 Feature Operation** **119**

---

M3901 Fixed Keys .....	119
Program a feature or an Auto Dial .....	121
Use Auto Dial .....	122
Use Speed Call .....	122
Use Call Transfer .....	123
Set up a Conference call .....	124
Activate Ring Again .....	125
Make a call .....	126
Receive a call .....	126
Feature Activation Indicator .....	126
Message Waiting and Call Status Indicator .....	126

<b>Accessories for the M3900 Series telephones</b>	<b>127</b>
Accessory Connection Module (ACM) .....	127
Analog Terminal Adapter (ATA) .....	127
Computer Telephony Integration Adapter (CTIA) .....	127
Display-based Expansion Module .....	127
External Alert and Recorder Interface .....	127
Full Duplex Hands Free Module .....	128
Headsets .....	128
Key-based Expansion Module .....	128
Personal Directory PC Utility .....	128
<b>Meridian 1 Flexible Feature Codes (FFCs)</b>	<b>129</b>
<b>Meridian SL-100 Feature Access Codes (FACs)</b>	<b>130</b>
<b>Index</b>	<b>131</b>



## M3900 Series Meridian Digital Telephone

There are five models in the M3900 Series Meridian Digital Telephone Portfolio. This document describes the **M3901**, **M3902**, **M3903**, and **M3904** features and how to use them. The **M3902**, **M3903**, and **M3904** are described in the main portion of this document. The **M3901** is described in a separate section of this document. For information on the **M3905** refer to the *M3905 Call Center Meridian Digital Telephone User Guide*.

### M3901

The **M3901** has one Line (DN) Key and can be programmed with up to five features.

#### M3901 telephone

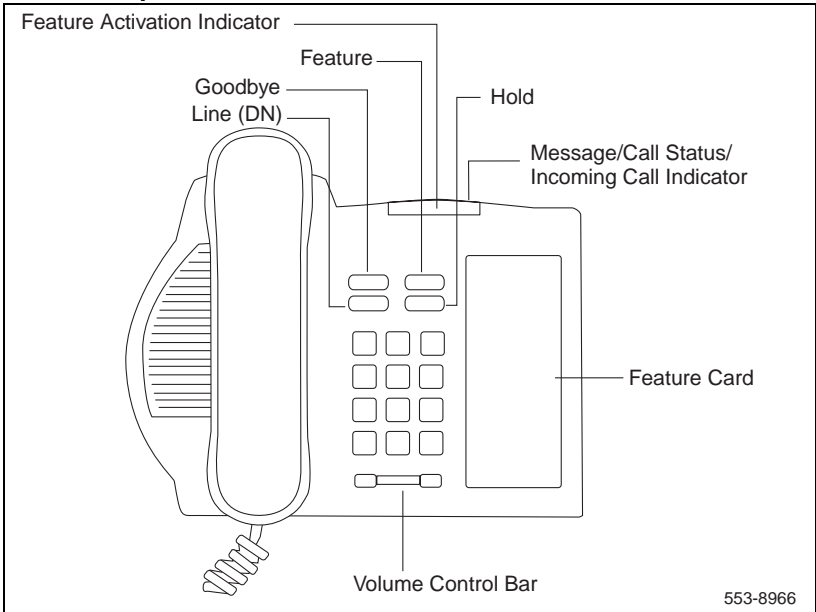

**Note:** The Meridian SL-100 configures the Line (DN) Key as a Directory Number only.

## M3902

The **M3902** has one Line (DN) Key, and three Programmable Soft Keys (self-labeled).

### M3902 telephone

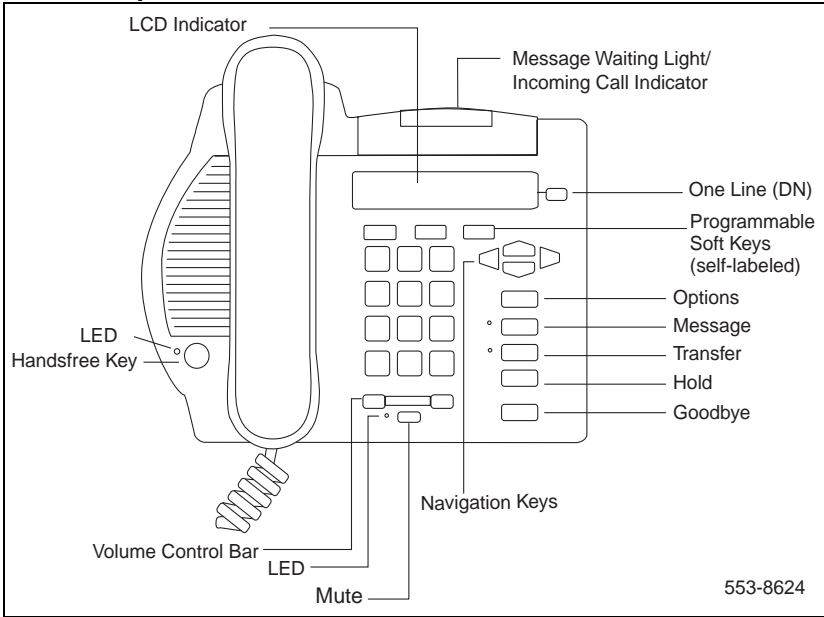

## M3903

The **M3903** has two Programmable Line (DN)/Feature Keys (self-labeled) with two features or lines configured on each key. It also has four Context Sensitive Soft Keys (self-labeled).

### M3903 telephone

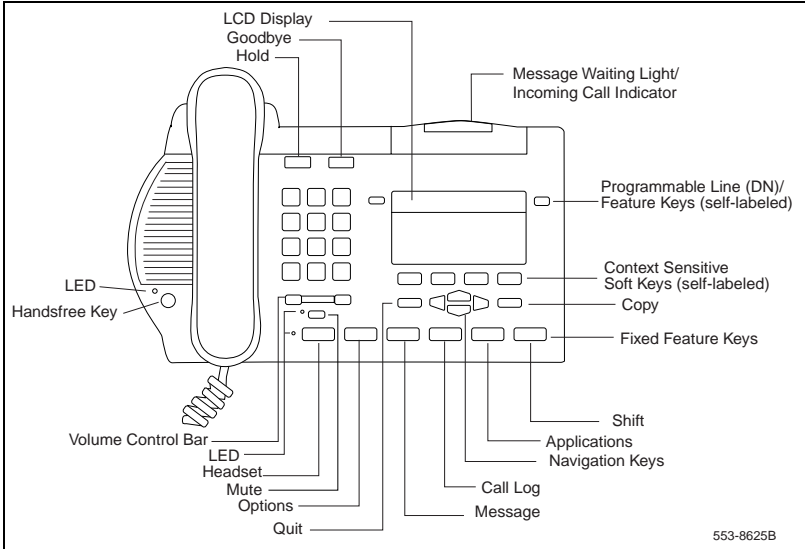

## M3904

The **M3904**, has six Programmable Line (DN)/Feature Keys (self-labeled), with two features or lines configured on each key. It also has four Context Sensitive Soft Keys (self-labeled).

### M3904 telephone

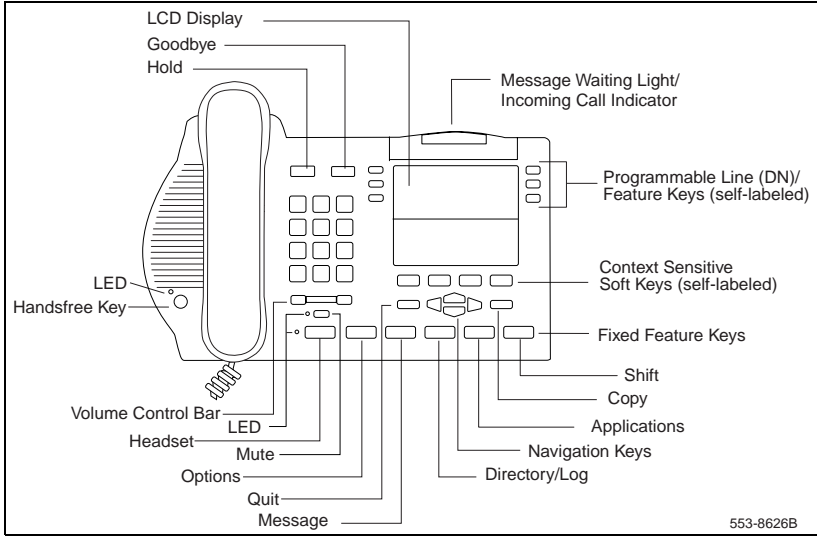

## Your Telephone's Controls



Use the **Volume Control Bar** to control the volume of the handset, headset, speaker, ringer, and handsfree. Increase the volume by pressing the right side of the bar. Lower it by pressing the left side.



You can terminate an active call by pressing the **Goodbye Key**. The **Goodbye Key** is useful for disconnecting a handsfree call.



Press the **Headset Key** to answer a call on a headset (connected to the headset jack) or to switch a call from handset or handsfree to the headset.



A steady LCD indicator appearing beside a **Line (DN) Key** means that the feature or line is active. A flashing LCD indicator means the line is on hold or the feature is being programmed.



By pressing the **Hold Key**, you can put an active call on hold. Return to the caller by pressing the DN Key beside the flashing indicator.



The **Handsfree Key** allows you to activate the handsfree (**M3902**, **M3903**, and **M3904**) and Group listening features (**M3903** and **M3904**). The speaker LED lights to indicate handsfree is active, the LED flashes to indicate Group listening is active.



The **Mute Key** allows you to listen to a conversation without being heard. This is especially useful when you only want to listen on a conference call. Push the Mute Key again to return to a two way conversation. The **Mute Key** applies to handsfree, handset, and headset microphones. The Mute LED flashes when the Mute option is in use.



The **Navigation** Keys allow you to scroll through Menus and lists on the display.

The **Copy** Key copies incoming or outgoing call numbers into the Personal Directory on the **M3904**.

The **Quit** Key ends an active application. Pressing the **Quit** Key does not affect the status of calls currently on your telephone.

**Note:** If you press the Quit Key before the Done Key you exit without saving changes. Press the Done Key to exit and save changes.



The **Options** Key allows you to access and modify telephone options.

The **Message** Key provides access to your voice messaging system.

The **Directory/Log** Key (**M3904**) allows you to access your Personal Directory (100 entries), Callers List (last 100 incoming calls) and, Redial list (last 20 outgoing calls).

The **Call Log** Key (**M3903**) allows you to access the Callers List (last 10 incoming calls), and the Redial list (last 5 outgoing calls).

The **Applications** Key allows you to access additional features that may be provided by your network administrator (**M3903** and **M3904**).

The **Shift** Key allows you to access the second layer of the Programmable Line/Feature Keys (**M3903** and **M3904**).

The **Line/Directory Number (DN)** Key on the **M3901** allows you to access dial tone.

2496



**Line/Directory Number (DN)** Key(s) are assigned to your **M3902**, **M3903**, or **M3904**. They can be a Primary Directory Number (PDN) or secondary DN(s) on the **M3903** and **M3904**.

2498



On the **M3903** and **M3904**, the lower right hand Line/Feature Key on the first layer is your **Primary Directory Number (PDN)** Key. When you pick up the handset, the line associated with this key is ready for you to make a call.

**Note:** Although you have only one PDN, you can have additional Line/Directory Number (DN) Key(s) assigned to your **M3903** or **M3904** telephone.

Dial



The **Dial** Key is used to dial numbers stored in the Directory and Callers List (**M3903** and **M3904**). The **Dial** Key accesses the Primary Directory Number (PDN) Key to make a call.

More...



The **More** Key allows you to access additional layers of Context Sensitive Soft Keys.

Example:

Trans



**Programmable Soft Keys (M3902)** or **Context Sensitive Soft Keys (M3903 and M3904)** are configured for various features and functions on the M3900 Series telephones. The **Soft Keys** are located below the display area. These keys have an LCD label above them that changes based on available features, functions, or the active application.

CallWait



**Programmable Line (DN)/Feature** Keys (**M3903** or **M3904**) are located at the sides of the upper display area. Once configured, these **Programmable Line (DN)/Feature** Keys provide one-touch feature activation. An status icon indicates call or feature status.

## Terms you should know

**Attendant** — The attendant is a telephone operator in your organization.

**Call Log**— The Call Log can be configured to store either unanswered or all incoming calls. These entries can be accessed through your directory menu.

**Call party information**—When your telephone rings, the display shows Call Party Name Display (CPND) information. The system must have CPND enabled. The display shows the phone number and name, if available, of the incoming call.

**Card View** — The Card View displays a directory entry name and telephone number.

**Context Sensitive Soft Keys** — The four keys located directly below the display on the **M3903** and **M3904** are referred to as Context Sensitive Soft Keys. The label and function of each key changes depending upon the available features or the active application.

**Copy Key** — The Copy Key allows the **M3904** to copy information from an application, like Corporate Directory, or from the Callers List or Redial List to the Personal Directory.

**Date/time display feature** —The Date/time display feature shows the month and date while the telephone is in an idle state.

**Directory Number (DN)** — The Directory Number (DN) is a telephone number that consists of one to seven digits. The DN is commonly known as an extension number.

**Feature Access Codes (FACs)**— Feature Access Codes (FACs) allow you to access features for which you do not have a fixed or soft feature key. Feature Access Codes are applicable to the Meridian SL-100 system only. For your convenience, the FACs for your system can be printed on a page located at the back of this guide.

**Flexible Feature Codes (FFCs)** —Flexible Feature Codes (FFCs) allow you to access features for which you do not have a fixed or soft feature key. Flexible Feature Codes are applicable to the Meridian 1 system only. For your convenience, the FFCs for your system can be printed on a page located at the back of this guide.

**Fixed Keys**—The Fixed Keys are the hard labeled keys on your telephone.

**Indicator** —An indicator is an LCD or LED that displays the current status of a feature by its state; flashing, winking, steady on, or off.

**Information screen**—The Information screen displays call activity, lists, prompts, and status of calls.

**Interrupted dial tone**—Interrupted dial tone is a broken or pulsed dial tone, heard when you access some of the features on your telephone.



**Meridian 1, Meridian SL-100**— The Meridian 1 or the Meridian SL-100 is your office communications system.

**More...** — The More Key allows access to the multiple layers of Programmable Soft Keys. These keys are the keys located below the display on your telephone.

**Off-hook** — Off-hook is a term used to indicate that the telephone is active and ready to make a call. Your telephone's status changes to off-hook when you pick up the handset or press a Line (DN) Key.

**Paging tone**—Paging tone is a special tone heard when using the Radio Paging feature. You hear two beeps followed by dial tone.

**Personal Directory** —The Personal Directory stores entries by name and phone number.

**Primary Directory Number**— The Primary Directory Number is the main extension number on your telephone. It is accessed through the Primary Directory Number (PDN) Key.

**Private Line** — Private Line can be assigned to your telephone. With this line, you can reach an outside number without dialing a code to access an outside line. Internal extensions cannot be dialed from a private line.

**Redial List**— The Redial List is accessed through the Call Log Key on the **M3903** and through the Directory/Log Key on the **M3904**. It lists outgoing numbers for calls that have been made from your telephone.

**Ringback/ring tone**— Ringback/ring tone is the sound you hear when a call you have made is ringing at its destination.

**Shared Directory Number** — A shared Directory Number is a DN (extension) that is shared by two or more telephones. This is also known as a Multiple Appearance DN (MADN).

**Special dial tone**— The special dial tone refers to three consecutive short tones followed by steady dial tone that you hear when accessing some of your telephone features.

**Switch hook** — The switch hook is the button which the handset presses down, disconnecting your call, when you replace the handset. When lifted, the handset releases the switch hook and you either answer an incoming call or you receive dial tone indicating that your telephone is ready to make a call.

## Your telephone call features

Your network administrator assigns features to your programmable feature keys. Whenever this guide describes a procedure that requires special codes ask your network administrator to provide these to you.

To access a feature, you press a Feature Key, or enter a Flexible Feature Code (FFC) for the Meridian 1 or a Feature Access Code (FAC) for the Meridian SL-100. Your network administrator supplies you with the Flexible Feature Codes or Feature Access Codes for your system.

**Note:** In order to use a feature described in this section, your system software must support the feature and the feature must be assigned to your telephone. Check with your network administrator for more details.

### Use handsfree calling (M3902, M3903, and M3904)

---

If your telephone is an **M3902**, **M3903**, or **M3904** you can use the built-in microphone and speaker instead of the handset to make or receive a handsfree call. While on an active call, you can switch between Handset and Handsfree mode.

**To answer a call with handsfree:**



Press the **Handsfree** Key. You are now on a handsfree call.

**To discontinue a handsfree call:**



Press the **Goodbye** Key to end the call.

**To mute a handsfree call:**



1. Press the **Mute** Key. The LED indicator flashes.



2. Press the **Mute** Key again to return to a two way handsfree conversation.

**To switch from handsfree to handset:**



1. Lift the **handset** to switch from handsfree to handset.

**To switch from handset to handsfree:**

1. Press the **Handsfree** Key.
2. Replace the **handset**.

**To use a headset:**

Connect a headset to the headset jack or the handset jack depending on the headset type and the telephone you are using.

Press the **Headset** Key (**M3903** and **M3904**). For the **M3902** read the instructions that came with your recommended headset.

**Note 1:** Refer to “Set On-hook default path” on page 89 for information on how to configure your telephone for use with a headset.

**Note 2:** Refer to “Headsets” on page 128 for information on recommended headset types for your telephone. This section also provides information on setting and adjusting the volume for both amplified and unamplified headsets.

**To switch from handsfree to headset:**

Connect headset or put headset on.

Press the **Headset** Key (**M3903** and **M3904**). For the **M3902** read the instructions for the headset you are using.

## Activate/deactivate Group listening

The **Group listening** feature allows others to listen to a call through the speaker while you are speaking through the handset. This feature must be enabled by your network administrator.

To activate the **Group listening** option:



GROUP LISTENING

Select



On



Done



Quit



To use **Group listening** while you are on a call:



1. Press the **Options** Key.
2. Use the **Navigation** Keys to scroll through the Options List and highlight **GROUP LISTENING**.
3. Press the **Select** Key.
4. Press the **On** Key.
5. Press the **Done** Key to save changes.
6. Press the **Quit** Key to exit.

Press the **Handsfree** Key. Everyone will hear the caller over the speaker, but the caller will only hear what is picked up by the handset.

**Note:** You must let the caller know when others are listening to the conversation. This feature does not provide a tone to inform the party on the other end of the call that the conversation is being monitored.

To deactivate the Group listening option:



Group listening

Select



Off



Done



Quit



To mute a group listening call:



To switch from Group listening to handsfree:



1. Press the **Options** Key.
2. Use the **Navigation** Keys to scroll through the Options List and highlight **Group listening**.
3. Press the **Select** Key.
4. Press the **Off** Key to turn Group listening off.
5. Press the **Done** Key to save changes.
6. Press the **Quit** Key to exit.

1. Press the **Mute** Key. The LED flashes.
2. Press the **Mute** Key again to return to two way conversation.

Press the **Handsfree** Key.

## Use the Predial feature

---

The **Predial** feature allows you to enter and preview a number containing up to 31 digits and make corrections before you dial the number.

To use Predial:



2637



1. Replace the **handset**, if it is off the cradle.

2. **Dial** the number.

**Note 1:** Press the **Pause** Key to insert a 1.5 second pause in the dialing string.

**Note 2:** If you are calling an external or long distance number, be sure that the appropriate access codes are included.

3. Press a **Line** (DN) Key to receive dial tone.

The displayed predialed number is automatically dialed.

4. Lift the **handset** when the called party answers or, if on handsfree, begin to talk.

**Note:** You cannot use the Predial feature if the Live dial pad feature is active.

## Make a call

This section describes features that you can use when you make a call. There are several ways to make a call from your M3900 Series Meridian Digital Telephone. To make a call from your telephone, use the features described in this chapter.

### To make a call:



or

2637



or



or



1. Lift the **handset**.

or

Press the **Line** (DN) Key.

or

Press the **Handsfree** Key.

**Note:** The Handsfree Key must be enabled by your network administrator

or

Press the **Headset** Key if you have a headset connected to your telephone's headset jack (available on the **M3903** and **M3904**).

**Note:** See "Set On-hook default path" on page 89, and "Headsets" on page 128 for information on connecting a headset to your **M3903** or **M3904**.

2. **Dial** the number.

**Note:** Whenever you read "Lift the handset," in this guide, you may alternatively press a free **Line** (DN) Key, **Handsfree** Key, or the **Headset** Key. You receive dial tone with each of these actions.

### To change from handset to headset:



The **Headset** Key is used to switch to the headset mode of operation.

The LED lights steadily to indicate that you are in headset mode.

## Make a call while on-hook

---

To make a call while on-hook, leave the handset in the cradle while you dial a number.

To dial on-hook:

2637



1. Press a **Line** (DN) Key.
2. **Dial** the number when you receive dial tone.
3. Lift the **handset** when the called party answers.

## Auto Dial

---

**Auto Dial** lets you dedicate a feature key to a specific telephone number. When the Auto Dial Key is pressed, the number is dialed automatically. This feature must be enabled by your network administrator.

To use **Auto Dial**:



AutoDial



1. Lift the **handset**.
2. Press the associated **Auto Dial** Key.  
The number is dialed automatically.

To display the Auto Dial number (**M3903** and **M3904**):

Display



1. Press the **Display** Key.

**Note:** On the Meridian SL-100, press the **Inspect** Key to display the number.

AutoDial



2. Press the configured **Auto Dial** Key.  
The number appears on the display.

To store an Auto Dial number:

AutoDial



1. Press the **Auto Dial** Key, without lifting the handset.





AutoDial



**Note:** To change the key label “AutoDial”, select Change feature key label from the **Options List** menu. Please see “Change a Feature Key label” on page 80 for detailed instructions.

## Ring Again (M3902)

Use the **Ring Again** feature when you dial a number and receive a busy tone or no answer. The Ring Again feature lets you know when the person you dialed is available or has used their telephone. The feature notifies you when to redial your party. The Ring Again feature automatically redials the number.

**To use Ring Again:**



RingAgain



**To call a Ring Again party when you receive notification:**



RingAgain



2. **Dial** the number to be stored on the Auto Dial Key.

**Note 1:** The number may contain up to 31 digits.

**Note 2:** Press the **Pause** Key to insert a 1.5 second pause in the dialing string.

**Note 3:** If you are storing an external or long distance number, be sure that the appropriate access codes are included.

3. Press the **Auto Dial** Key again. The number is stored on the key.

1. **Dial** a number and receive a busy tone or no answer.

**Note:** On the Meridian SL-100, Ring Again is available on busy tone only.

2. Press the **Ring Again** Key, or enter the Ring Again Activate FFC.

When the number you want to reach is available, or the person has re-used their set, you hear the Ring Again tone.

1. Lift the **handset**, you receive dial tone.

**Note:** If you used the Ring Again Activate FFC, the number is automatically dialed.

2. Press the **Ring Again** Key.

To cancel Ring Again before notification:

RingAgan



Press the **Ring Again** Key a second time before hearing the notification tone, or enter the Ring Again Deactivate FFC.

## Ring Again (M3903 and M3904)

---

Use the **Ring Again** feature when you dial a number and receive a busy tone or no answer. The Ring Again feature lets you know when the person you dialed is available or has used their telephone. The feature notifies you when to redial your party. The Ring Again feature automatically redials the number.

To use Ring Again:



RingAgan



1. **Dial** a number and receive a busy tone or no answer.

**Note:** On the Meridian SL-100, Ring Again is available on busy tone only.

2. Press the **Ring Again** Key.

The screen displays Ring again is active.

To call a Ring Again party when you receive notification:



RngCall



When the number you want to reach is available, or the person has re-used their set, you hear the Ring Again tone.

1. Lift the **handset** or press a line (DN) key.
2. Press the **Ring Call** Key.

To cancel Ring Again before notification:

CancelRA



Press the **Cancel Ring Again** Key.

The screen displays Ring Again is cancelled.

## Redial last number called

---

**Last Number Redial** allows you to automatically redial the last number you dialed. This feature must be enabled by your network administrator.

**To use Last Number Redial when using the handset:**



2637



1. Lift the **handset**.
2. Press a **Line** (DN) Key.

**To use Last Number Redial when using handsfree:**

2637



2637



Press the **Line** (DN) Key twice.

The last number you dialed is automatically redialed.

**Note:** On Meridian SL-100, press the **#** Key twice.

## Use Speed Call (M3902)

The **Speed Call** feature allows you to automatically dial frequently called numbers by entering a one, two, or three digit access code. Contact your network administrator to determine the capacity of your Speed Call list. This will establish the number of digits you will enter for each access code.

A telephone designated as a Speed Call Controller can program or edit the Speed Call list. This feature must be enabled by your network administrator.

### To store or change a Speed Call number:

SpCtIr



SpCtIr



1. Press the **Speed Call Controller** Key, or lift the handset and enter the Speed Call Controller FFC.

The triangular icon flashes, indicating programming mode.

2. The phone prompts you to **dial** a one, two, or three digit code and the telephone number.

**Note:** Dial the access code (if required) followed by the internal, external, or long-distance telephone number.

3. Press the **Speed Call Controller** Key again, or enter the Speed Call Controller FFC.

The code and number are saved. The flashing icon turns off.

### To make a Speed Call:



SpCtIr



or

SpCtUsr



1. Lift the **handset**.
2. Press the **Speed Call Controller** key or the **Speed Call User** Key, or enter the Speed Call User FFC.
3. **Dial** the Speed Call code assigned to the telephone number.

The number is automatically dialed.

## Use Speed Call (M3903 and M3904)

The **Speed Call** feature allows you to automatically dial frequently called numbers by entering a one, two, or three digit access code. Contact your network administrator to determine the capacity of your Speed Call list. This will establish the number of digits you will enter for each access code.

A telephone designated as a Speed Call Controller can program or edit the Speed Call list. This feature must be enabled by your network administrator.

**To store or change a Speed Call number:**

SpCCtrl



Done



**To make a Speed Call:**



SpCCtrl



or

SpCUsr



1. Press the **Speed Call Controller** Key.

The screen displays Enter Code, then number.

2. **Dial** a one, two, or three digit code. Use the **Delete** Key if you make a mistake. Use the **Cancel** Key to leave the screen without storing a speed call number.

**Note:** A dash is automatically inserted after the required number of digits have been entered.

3. **Dial** the associated telephone number. Use the **Delete** Key if you make a mistake. Use the **Cancel** Key to leave the screen without storing a speed call number.

**Note 1:** Dial the access code (if required) followed by the internal, external, or long-distance telephone number.

4. Press the **Done** Key to save the code and number.

1. Lift the **handset**.

2. Press the **Speed Call Controller** Key or the **Speed Call User** Key.

The screen displays Enter code.



3. **Dial** the Speed Call code assigned to the telephone number.

The number is automatically dialed.

## Make a System Speed Call

---

**System Speed Call** allows you to make a call by dialing Speed Call codes which may override your telephone's class of service restrictions. The System Speed Call feature is set up on the system by your network administrator. It is a speed dial number that is common to many users, therefore it is set up on the system not on your individual telephone.

**To make a System Speed Call:**



SScCtlr or SScUser  
 or 



1. Lift the **handset**.
2. Press the **System Speed Call Controller** key or the **System Speed Call User** Key, or enter the System Speed Call User FFC (Meridian 1) or FAC (Meridian SL-100).
3. **Dial** the Speed Call code assigned to the telephone number.

The number is automatically dialed.

## Use Hot Line

---

The network administrator can program a **Hot Line** Key that allows you to dial a specific number automatically. The network administrator can apply other features to the Hot Line such as Call Redirection, so that the Hot Line call is answered by a person and not by a voice mail box.

**To use Hot Line:**

Hotline



Press the **Hot Line** Key.

The Hot Line Key automatically dials the number.

**Note 1:** On the Meridian SL-100 system, the Automatic Line (AUL) feature is the same as the Hot Line feature.

**Note 2:** If your main DN is a Hot Line, lift the handset. The Hot Line dials the number automatically.

## Make an Intercom call

The **Intercom** feature connects a group of people together through an Intercom Key. You can use the Intercom feature to call a member of your intercom group by pressing a code assigned to each member of the group. The intercom group must be set up by your network administrator.

To make an Intercom call:



Intercom



1. Lift the **handset**.
2. Press the **Intercom** Key.
3. **Dial** the one or two digit code for the intercom group member you wish to call.

To answer an Intercom call while on a line other than your Intercom group line:



or



1. Press the **Hold** Key to put the current call on hold.
- or**
- Press the **Goodbye** Key to end the call.

Intercom



2. Press the **Intercom** Key and begin to speak.

## Answer a call

When you receive an incoming call, your telephone rings and the LCD indicator flashes.

To answer a call:



or



or

2637



or



Lift the **handset**.

or

Press the **Handsfree** Key (**M3902**, **M3903**, and **M3904**).

or

Press the **Line** (DN) Key beside the LCD indicator as it flashes.

or

Press the **Headset** Key if you have a headset connected to your telephone (available on the **M3903** and **M3904**).



## While on an active call

This section describes features that you can use while on an active call.

### Place a call on Hold

Use the **Hold** feature when you are talking with one party and a second call comes in on a second line. You can answer the second call and retain the original call by putting it on Hold.

**To place a call on Hold:**



Press the **Hold** Key.

The LCD indicator flashes beside the line on hold.

**Note 1:** If the Automatic Hold feature is configured for your Meridian 1, the active call is automatically put on hold when you answer the second call.

**Note 2:** On the Meridian SL-100 Automatic Hold is the default feature.

**Note 3:** The caller hears music while on hold, if the Music on Hold feature is configured for your system.

**To retrieve a call on hold:**



Press the **Line** (DN) Key beside the flashing LCD indicator.

### Transfer a call (M3902)

Use the **Transfer** feature to redirect a call to a third party.

**To use the Transfer feature:**



1. Press the **Transfer** Key.

The other party is on hold and you receive dial tone. The LED indicator light flashes steadily.

2. **Dial** the number of the telephone where the call is to be transferred.





3. When you hear the ring or a person answers, press the **Transfer** Key to complete the call transfer.

The LED indicator goes from steady on to off.

To go back to the original call if the transfer is incomplete:



If the person you called is not available, press the **Line** (DN) Key to reconnect to the original call.

**Note:** On the Meridian SL-100, press the **Transfer** Key, dial the number and press the **Goodbye** Key. If you press the **Transfer** Key the second time, you get a three way conference.

## Transfer a call (M3903 and M3904)

---

Use the **Transfer** feature to redirect a call to a third party.

To use the Transfer feature:

Trans



Swap



or

Connect



1. Press the **Transfer** Key.  
The other party is on hold and you receive a dial tone. The screen displays Call on hold, dial number.
2. **Dial** the number of the telephone where the call is to be transferred.
3. Press the **Swap** Key to switch between talking with the original caller and the new caller. Press the **Connect** Key to complete the transfer.

The two callers are connected and your telephone is ready to make or receive new calls.

To go back to the original call if the transfer is incomplete:



1. Press the **Goodbye** Key.
2. Press the **Line** (DN) Key with the flashing icon to return to your original call.

## Use Timed Reminder Recall

**Timed Reminder Recall** gives you a reminder tone when a call you transferred is not answered.

To use Timed Reminder Recall:



1. Press the **Transfer** Key. The call is put on hold.
2. **Dial** the number where you want to transfer the call.
3. Press the **Transfer** Key again.

**or**

Replace the **handset** before the person answers. This starts the recall timer.

**Note 1:** On the Meridian SL-100, do not press the Transfer Key again; replace the handset before the person answers. Meridian SL-100 uses the Blind Transfer Recall feature.

**Note 2:** If the transfer is complete, the recall timer stops.

If the transferred call is not answered, your telephone rings:



1. Lift the **handset**.
2. Press the **Transfer** Key and repeat the transfer (to a different DN).

**Note:** If you transfer a call to a person and they pick up the line while you are still on the line, press the Goodbye Key to complete the transfer. Check with your network administrator to determine the time interval of your recall timer.

## Use Attendant Recall

---

The **Attendant Recall** feature allows you to contact an attendant while on a call and connect the call to the attendant.

To contact the attendant while on a call:



1. Press the **Attendant Recall** Key while on a call.

Stay on the line until the attendant answers.

2. Press the **Goodbye** Key.

The caller remains connected to the attendant.

**Note:** On the Meridian SL-100, the Attendant Recall Key is not available; use the Transfer Key to connect a call to the attendant.

## Use Call Park (M3902)

---

The **Call Park** feature allows a call to be held temporarily and to be retrieved from any telephone. You can park an incoming call and page the called party. When you use Call Park, you do not tie up a line. Your network administrator can set up a System Park Extension where most calls are automatically parked.

If configured network-wide, Call Park can be used across networks.

### To Park a call on the System Park DN or your own DN:



Press the **Park** Key.

If there is a System Park DN, the call automatically parks on the System Park DN. Otherwise, it parks on your DN.

**Note:** On the Meridian SL-100, press the Park Key and you receive a confirmation tone. Press the Park Key again or the Goodbye Key.

### To park a call on a DN other than the System Park DN or your own DN:



1. Press the **Park** Key.
2. **Dial** the DN where you want to park the call.
3. Press the **Park** Key.

**Note:** On Meridian SL-100, press Directed Call Park (DCPK) Key. Dial the DN where you want to park the call. Press DCPK again.

### To park a call using FFCs/FACs:

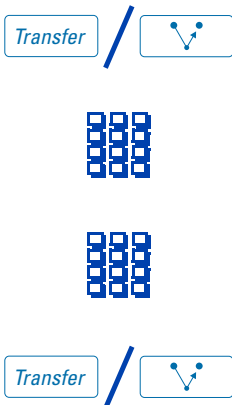

1. Press the **Transfer** Key.
2. **Dial** the Park Call FFC (Meridian 1), or the Directed Call Park or System Call Park FAC (Meridian SL-100).
3. If you do not want the System Park DN or your own DN, **Dial** a DN where you want to park the call.
4. Press the **Transfer** Key.

To retrieve a parked call:

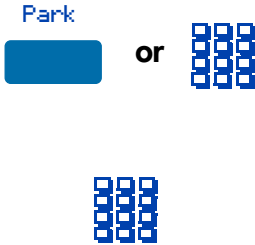

1. Lift the **handset**.
2. Press the **Park** Key, or to retrieve the call using FFCs/FACs; **Dial** the Park Call Access FFC (Meridian 1), or the Directed Call Park or System Call Park FAC (Meridian SL-100).
3. **Dial** the DN where you parked the call.

**Note:** If a parked call is not retrieved within a specified period of time, it rings back to your telephone or to the attendant. Check with your network administrator to determine your specified period of time.

## Use Call Park (M3903 and M3904)

The **Call Park** feature allows a call to be held temporarily and to be retrieved from any telephone. You can park an incoming call and page the called party. When you use Call Park, you do not tie up a line. Your network administrator can set up a System Park Extension where most calls are automatically parked.

If configured network-wide, Call Park can be used across networks.

To park a call on a System Park DN:



1. Press the **Park** Key.  
The screen displays a System Park DN and asks for confirmation.
2. Press the **OK** Key. The call parks on the System Park DN.

**Note:** On the Meridian SL-100, the screen displays **Park** on the first line. On the second line, the screen displays **Call Parked**. Press the **Goodbye** Key to complete the call park process. The call is parked on your own DN.

### To park a call on a DN other than the System Park DN on the Meridian 1:

Park  



OK  

1. Press the **Park** Key.

The screen displays `Press OK to Park call on 2190` (Where 2190 represents the default System Park DN).

2. **Dial** the DN where you want to park the call.

When you begin dialing, the screen displays `Enter digits`, then `Park`. When you have completed dialing the call park DN, the screen displays `Press OK to Park call`.

3. Press the **OK** Key.

The call parks on the selected DN.

### To park a call on a DN other than the System Park DN on the Meridian SL-100:

DirectPark 



DirectPark 

1. Press the **Direct Park** Key.

2. **Dial** the DN where you want to park the call.

**Note:** Press the  key twice to park the call on the System Park DN.

3. Press the **Direct Park** Key.

The call parks on the selected DN.

To retrieve a parked call on the Meridian 1:



1. Lift the **handset**.
2. **Dial** the DN where you parked the call.

**Note:** If a parked call is not retrieved within a specified period of time, it rings back to your telephone or to the attendant. Check with your network administrator to determine your specified period of time.

To retrieve a parked call on the Meridian SL-100:



DirectPark



1. Lift the **handset**.
2. Press the **Direct Park** Key or enter the Call Park FAC.
3. **Dial** the DN where you parked the call.

**Note 1:** If a parked call is not retrieved within a specified period of time, it rings back to your telephone or to the attendant. Check with your network administrator to determine your specified period of time.

**Note 2:** Check with your network administrator to determine your System Park DN.



## Calling Party Number (M3902)

The **Calling Party Number** feature allows you to record a caller's number, for accounting purposes, while on an established call. **Note:** This feature is not available on the Meridian SL-100.

To record a caller's number:

CParty



CParty



1. Press the **Calling Party** Key. Enter number appears on the display.
2. **Dial** the calling party's telephone number.
3. Press the **Calling Party** Key.

## Calling Party Number/Charge Account (M3903 and M3904)

The **Calling Party Number/Charge Account** feature allows you to record a caller's number or charge account number for accounting purposes while on an established call.

To record the calling party number or charge account number (Meridian 1):

Charge



Account



or

CParty



OK



1. Press the **Charge** Key. The screen displays **Select Charge type**.
2. Press the **Account** Key. The screen displays **Enter account number**.  
  
**or**  
Press the **Calling Party Number** Key. The screen displays **Enter Calling Party number**.
3. **Dial** the charge account number or calling party number. Use the **Clear** Key or **Delete** Key to edit the number. Press the **Exit** Key to leave the screen without charging the call.
4. Press the **OK** Key. You return to your call.

To record a charge account number  
(Meridian SL-100):



1. Lift the **handset** and ask the calling party to hold
2. Flash the switch hook
3. **Dial** the Account Code FAC.  
You receive dial tone.
4. **Dial** the account code digits.
5. Flash the switch hook.  
You are returned to your call.

## Display incoming calls

---

The **Display** Key allows you to be on an active call and display an incoming caller's name and/or number, if not automatically displayed, without interfering with the call in progress.

To view the name of a second caller  
while on a call in progress:

Display 

2637  

1. Press the **Display** Key.
2. Press the flashing **Line** (DN) Key. The call waiting information appears on the display.

**Note 1:** Use of the **Display** Key does not interfere with the call in progress.

**Note 2:** You can use the **Display** Key in combination with other feature keys to display information associated with the feature.

**Note 3:** On the Meridian SL-100, while on an active call, press the **Inspect** Key to view information on an incoming call.

## Trace a Malicious call

**Malicious Call Trace** provides a way for you to trace nuisance calls. The feature is available for both internal and external calls. When the key is pressed, your Directory Number and the telephone number of the caller are recorded for access by your network administrator.

To use **Call Trace** while you are on a call:

CallTrace 

Press the **Call Trace** Key.

**Note:** On the Meridian SL-100, press the **MalcsHold** (Malicious Call Hold) Key.

To use **Call Trace** if you do not have a **Call Trace** Key:

Trans  or  Conf

1. Press the **Transfer** Key **or** the **Conference** Key.

**Note:** On the Meridian SL-100, press only the Transfer Key.



2. **Dial** the Malicious Call Trace FFC (Meridian 1) **or** the Malicious Call Hold FAC (Meridian SL-100).

2637  

3. Press the **Line** (DN) Key beside the flashing LCD indicator to return to the call.

**Note:** On the Meridian SL-100, after dialing the Malicious Call Hold FAC, you are automatically reconnected to the calling party.

## Incoming calls

This section describes features that you can use with incoming calls.

### Activate Automatic Answerback

---

When **Automatic Answerback** is active, your set automatically answers in handsfree mode after one ring.

**Note:** When Automatic Answerback is active, calls do not forward to your voice message service.

To use **Automatic Answerback**:



Press the **Automatic Answerback** Key.

To deactivate **Automatic Answerback**:



Press the **Automatic Answerback** Key.

## Use Call Pickup

**Call Pickup** allows you to pick up a call from any telephone in the same Pickup Group or another Pickup Group. This feature must be enabled by your network administrator.

**To answer a call in your own Call Pickup Group:**



Pickup



1. Lift the **handset**.
2. Press the **Pickup** Key or enter the Pickup Ringing Number FFC (Meridian 1) or FAC (Meridian SL-100).

**To answer an incoming call in another Call Pickup Group:**



GrpPickup



1. Lift the **handset**.
2. Press the **Group Pickup** Key or enter the Pickup Group FFC.
3. **Dial** the Pickup Group number of the telephone that is ringing.

**Note 1:** The network administrator assigns the Pickup Group number.

**Note 2:** This feature is not applicable on the Meridian SL-100 system.

**To answer a call at a specific extension within your Pickup Group:**



DNPickup



1. Lift the **handset**.
2. Press the **DN Pickup** Key, or enter the Pickup Directory Number FFC (Meridian 1) or the Directed Call Pickup FAC (Meridian SL-100)
3. On the Meridian SL-100, dial the extension number of the ringing telephone.

**Note:** If the pickup DN is invalid, you receive an overflow burst tone, and the screen displays **Release and try again**. Press the **Goodbye** Key.

## Use Call Waiting

**Call Waiting** puts your current call on hold, while you answer an incoming call. Example: The attendant routes an outside call to you while you are on an existing call. Call Waiting allows you to recognize the call and respond to it. This feature must be enabled by your network administrator.

**To answer an incoming call while on another call:**



1. Press the **Hold** Key when you hear the tone.

The Call Waiting status icon appears in the display.



2. Press the **Call Wait** Key (**CWait** for **M3902**) to answer the call.

**To return to your first telephone call:**



1. Press the **Hold** Key, if you want to put the second call on hold.

or

or



Press the **Goodbye** Key to end the second call.

2. Press the **Line** (DN) Key associated with the first call.

**If you do not have a Call Waiting Key:**



1. If you do not have a Call Waiting Key and you hear the Call Waiting tone, press the **Goodbye** Key to end your current call.



2. Press the **Line** (DN) Key beside the flashing status icon to answer the incoming call.

## While you are away from your desk

This section describes features that you may wish to use when you are away from your desk.

### Forward calls (M3902)

The **Call Forward** feature allows you to direct your calls to ring at another Line (DN). You cannot forward calls while your telephone is ringing.

To forward your calls:

Forward



Forward



1. Press the **Forward** Key, or lift the handset and enter the Call Forward All Calls Activate FFC (Meridian 1) or FAC (Meridian SL-100).
2. **Dial** the DN where you want to forward your calls.
3. Press the **Forward** Key.

To view the number that your calls are being forwarded to:

Display



Forward



1. Press the **Display** Key, or lift the handset and enter the Call Forward All Calls Verify FFC.

**Note:** On the Meridian SL-100, press the **Inspect** Key instead of the **Display** Key.

2. Press the **Forward** Key.

This action displays the forward number and leaves Call Forward active.

To cancel Call Forward:

Forward



Press the **Forward** Key, or lift the handset and enter the Call Forward All Calls Deactivate FFC (Meridian 1) or FAC (Meridian SL-100).

To reinstate Call Forward to the same number:

Forward Forward



Press the **Forward** Key twice.

## Forward calls (M3903 and M3904)

---

The **Call Forward** feature allows you to direct your calls to ring at another Line (DN). You cannot forward calls while your telephone is ringing.

To forward your calls:

Forward



Done



To view the number that your calls are being forwarded to:

CheckFw



Exit



To cancel Call Forward:

CheckFw



Canc1Fw



1. Press the **Forward** Key.  
The previously stored forward number appears, if one exists, and the screen displays Enter forward number.
  2. If desired, enter a new number. The existing number is automatically deleted. If you make a mistake, use the **Delete** Key to delete the previous digit(s). Press **Cancel** to leave this screen without forwarding your telephone or changing the number.
  3. Press the **Done** Key to activate Call Forward.
- 
1. Press the **Check Forward** Key.
  2. Press the **Exit** Key to return to the previous screen.  
This action will leave Call Forward active.
- 
1. Press the **Check Forward** Key.
  2. Press the **Cancel Forward** Key.



## Forward internal calls only

**Internal Call Forward** allows only calls originating at internal DNs to ring at another DN. Calls originating outside your Meridian 1 system will still ring at your telephone. You cannot forward calls while your telephone is ringing.

To forward your internal calls:

IntForward



IntForward



1. Press the **Internal Call Forward** Key, or lift the handset and enter the Internal Call Forward Activate FFC.
2. **Dial** the DN where you want to forward your calls.
3. Press the **Internal Call Forward** Key.

To cancel Internal Call Forward:

IntForward



Press the **Internal Call Forward** Key, or lift the handset and enter the Internal Call Forward Deactivate FFC.

To reinstate Internal Call Forward to the same number:

IntForward



IntForward



Press the **Internal Call Forward** Key twice.

**Note:** The Meridian SL-100 uses the Call Forward Busy/Don't Answer - Internal/External FAC. This feature allows Meridian SL-100 user to:

- Forward an incoming call which originated internally from a DN in the same customer group as you.
- Forward an incoming call which originated externally from a DN out of your customer group to a DN outside your customer group.

## Use Remote Call Forward

The **Remote Call Forward** feature allows you (from any telephone other than your own) to forward your calls to any telephone.

**Note:** On the Meridian SL-100, dial the Remote Access Directory Number. You are prompted to enter the directory number of your telephone, your PIN, and the Call Forwarding authorization code. Follow the prompts to activate, deactivate, or change call forwarding to a new destination.

### To activate Remote Call Forward:



1. Lift the **handset**.



2. If you call from a telephone outside the system, first **dial** your Direct Inward System Access number and wait for dial tone.



3. **Dial** the Remote Call Forward Activate FFC to activate the feature.



4. **Dial** your Station Control Password.

**Note:** Refer to “Secure your telephone” on page 44.



5. **Dial** your DN.

You get a dial tone before you dial your number.



6. **Dial** the number where you want to forward your calls. If you forward calls to an invalid number, you receive a fast busy tone.



7. Press the **#** Key.

To forward calls to a previous call forward telephone number, skip step six above.

To cancel Remote Call Forward:



1. Lift the **handset**.
2. If you call from a telephone outside the system, first **dial** your Direct Inward System Access number and wait for dial tone.
3. **Dial** the Remote Call Forward Deactivate FFC.
4. **Dial** your Station Control Password.
5. **Dial** your DN.  
You get a dial tone before you dial your number.
6. Press the **#** Key.

**Note:** When you use the Remote Call Forward feature to change the number to which your calls are being forwarded, this information is not updated on the display of your M3900 Series telephone. The telephone's display will continue to show the last call forward number that was entered from the telephone using the Call Forward feature.

## Secure your telephone

You can lock your telephone with a password to prevent unauthorized use of your telephone. **Note:** This feature is not available on the Meridian SL-100.

To lock your telephone:



1. Lift the **handset**.
2. **Dial** the Electronic Lock Activate FFC and your Station Control Password.

**Note:** If you perform this operation from someone else's telephone, also dial your DN.

3. Press the **Goodbye** Key.

To unlock your telephone:



1. Lift the **handset**.
2. **Dial** the Electronic Lock Deactivate FFC and your Station Control Password.

**Note:** If you perform this operation from someone else's telephone, also dial your DN.

3. Press the **Goodbye** Key.

To change your password (must be done from your telephone):



1. Lift the **handset**.
2. **Dial** the Station Control Password Change FFC and your current password. **Dial** your new password twice (for verification).
3. Press the **Goodbye** Key.

## Talk with more than one person

This chapter describes features which allow you to talk with more than one person at the same time.

### Set up a Conference call (M3902)

You can set up a **Conference** call for up to six people (including yourself). Contact your network administrator to determine the maximum number of people your system allows on a conference call.

To set up a conference call:



1. Press the **Conference** Key while you are on a call.

The other party is on hold and you receive a dial tone.

2. **Dial** the number of the person you want to add to the conference.

3. Press the **Conference** Key when the person answers.

Everyone is able to join the conversation.

If the person you attempt to add to the conference is unavailable:



1. Press the **Goodbye** Key.

2. Press the **Line** (DN) Key to return to your original call.

## Set up a Conference call (M3903 and M3904)

---

You can set up a **Conference** call for up to six people (including yourself). Contact your network administrator to determine the maximum number of people your system allows on a conference call.

To set up a conference call:

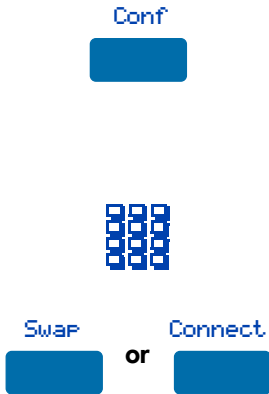

1. Press the **Conference** Key while you are on a call.

The other party is on hold and you receive dial tone. The screen displays **Call on hold, dial number**.

2. **Dial** the number of the person you want to add to the conference.
3. Press the **Swap** Key to switch between talking with the original caller and the new caller. Press the **Connect** Key to complete the conference.

Everyone is able to join the conversation.

If the person you attempt to add to the conference is unavailable:



1. Press the **Goodbye** Key.
2. Press the **Line (DN)** Key with the flashing icon to return to your original call.

## Join a call (M3902)

---

The **Call Join** feature allows you to connect an incoming call to a call already in progress thereby creating a conference call. In order to use Call Join, your telephone must be configured with either a second line (DN) or a Call Waiting Key.

**To connect a call on hold (on a different line) to your current call:**



1. Press the **Conference** Key.
2. Press the **Key** that has the caller you want to connect to your current call.
3. Press the **Conference** Key again.

The person on hold joins your conversation.

## Join a call (M3903 and M3904)

---

The **Call Join** feature allows you to connect an incoming call to a call already in progress thereby creating a conference call. In order to use Call Join, your telephone must be configured with either a second line (DN) or a Call Waiting Key.

**To connect a call on hold (on a different line) to your current call:**

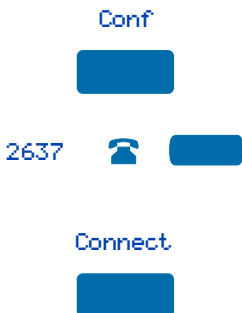

1. Press the **Conference** Key.
2. Press the **Key** that has the caller you want to connect to your current call.
3. Press the **Connect** Key.

The person on hold joins your conversation.

## Selectable Conferee Display and Disconnect

---

You can view the list of active conferees by using the **Conferee Selectable Display** Key and disconnect any party that has been added to the conference call. This feature is not available on the Meridian SL-100 system.

To view active conferees:

ConfSe1Dsp



1. While on a conference call, press the **Conferee Selectable Display** Key. The LCD indicator turns on. With each key press, the screen changes to show a different active conferee.

**Note:** This action has no effect on the displays of the other telephones involved in the conference.



2. Press the **Goodbye** Key. If configured, the Conference Count Display returns. The LCD indicator turns off.

To disconnect a conferee:

ConfSe1Dsp



1. While on a conference call, press the **Conferee Selectable Display** Key. The LCD indicator turns on. Continue to press the key until the conferee you want to delete appears on the screen.
2. Press the **Line** (DN) Key on which the conference call is established. The selected conferee is disconnected from the call.

**Note:** If there are additional conferees to be disconnected, press the **Conferee Selectable Display** Key until the conferee that is to be disconnected is displayed on the screen.

2637



3. Press the **Goodbye** Key. If configured the Conference Count Display returns and is updated to reflect the revised total count of conferees. The LCD indicator turns off.



## Use Group Call

**Group Call** automatically calls members of a predefined group, one at a time, until they have all answered. Ask your network administrator for details on how to create a conference call group.

To call group members:



GroupCall



1. Lift the **handset**.
2. Press the **Group Call** Key or enter the Group Call FFC.

The feature automatically calls all group members. The icon flashes until all members answer.

Their phone numbers appear on the display as they answer. When the last person answers, the **Group Call** indicator lights steadily.

**Note 1:** When a person in your group is on a conference call or another group call, they are not connected to your group call.

**Note 2:** After all the people in the group have answered, only the person who made the group call can put the call on hold.

**Note 3:** On the Meridian SL-100, use the Preset Conference feature for group calls. Dial the specific DN for Preset Conference, simultaneous ringing of the pre-selected parties is activated.

To answer a Group Call:



Lift the **handset**.

**Note 1:** If you are on a call and you receive three 10-second tones, this is the notification of a group call on your current extension.

**Note 2:** If you are on a call on another line on your telephone (**M3903** and **M3904**) when a group call is made, you receive a long tone through the handset or speaker.

**Note 3:** You do not receive notification of a group call if you are already on a conference call or another group call.

To end a Group Call:



Press the **Goodbye** Key.

**Note:** When the person who made the group call disconnects, the call terminates for all members of the group. However, the members of the Group Call can disconnect from the call and not affect other members on the call.

## Work without interruption

This chapter describes features that provide you with uninterrupted work time.

### Activate Make Set Busy

---

**Make Set Busy** allows you to make your telephone appear busy to all callers.

To activate **Make Set Busy**:

MakeSetBsy 

Press the **Make Set Busy** Key, or lift the handset and enter the **Make Set Busy Activate FFC**.

To deactivate **Make Set Busy**:

MakeSetBsy  

Press the **Make Set Busy** Key a second time to deactivate the feature, or lift the handset and enter the **Make Set Busy Deactivate FFC**.

# Additional Call Features

## Auto Dial Transfer Feature

---

**Auto Dial Transfer** allows you to use your Auto Dial Key to transmit digits to the central office after a Trunk Switch Hook Flash. You must be on a central office/exchange (CO) trunk call from or to a CO which offers Centrex or exchange line-type features.

**To use Auto Dial Transfer when you pick up an incoming trunk call:**

CentrexSHF



1. Press the **Centrex Switch Hook Flash** Key and wait for interrupted dial tone.

**Note:** On the Meridian SL-100, Press the **Transfer** Key instead of the Centrex Switch Hook Flash Key. Auto Dial can be used to transfer calls however, you do not have to be on a central office trunk call, and the Centrex Switch Hook Flash key is not applicable to the Meridian SL-100.

AutoDial



2. Press the **Auto Dial** Key to call the number desired.

Goodbye



3. Press the **Goodbye** Key to end the call.

## Use the buzz signal

---

**Buzz** allows one person, whose telephone is linked to another telephone, to signal the other telephone. The person signaled hears a buzz. Use this feature to notify the other person of a call, a visitor, or a request.

**To buzz the telephone linked to yours:**

Buzz



Press the **Buzz** Key.

The telephone linked to yours, buzzes as long as you hold down the key.

**Note:** Buzz signal is not available on the Meridian SL-100.

## Call Page to make an announcement

**Call Page** allows you to make an announcement over the paging system. To make a page call, dial the paging trunk access code.

**Note:** When the Page Key is used on an attendant console it overrides the telephones; the telephones are disconnected and must re-access the paging trunk.

**To connect to the paging system:**

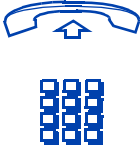

1. Lift the **handset**.
2. **Dial** the paging trunk access code.  
The connection to the paging system is complete.
3. Make your announcement.

**To disconnect from the paging system:**



Press the **Goodbye** Key.

## Centrex/Exchange Switch Hook Flash

**Centrex/Exchange Switch Hook Flash** allows you to signal the Central Office/Exchange (CO) during an established call to use a Centrex service such as call transfer or three-way calling.

**To use Centrex/Exchange Line Switch Hook Flash:**

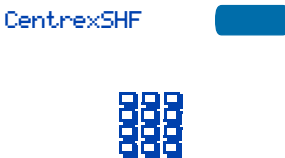

1. Press the **Centrex Switch Hook Flash** Key. You receive special dial tone.
2. **Dial** the codes for your custom Centrex feature.
3. Press the **Goodbye** Key to end the call.



**Note:** The Meridian SL-100 is a central office based PBX, and this feature is not available.

## Charge or Force Charge a call (M3902)

**Call Charge** allows you to charge a call to a specific account. **Forced Charge Account** allows you to charge long-distance calls from a telephone restricted to local calls.

**Note:** On the Meridian SL-100, the account code allows a user to enter a billing number. If the account code is required, the user is prompted to enter a code by a tone after the telephone number is dialed. If a user wishes to voluntarily enter an account code, then flash the switch hook and enter the Account Code FAC. Flash the switch hook again to return to the call.

To charge or force charge a local or a long-distance call to an account before you dial:



Charge



1. Lift the **handset**.
2. Press **Charge** Key, or enter the Call Detail Recording Charge Account FFC.
3. **Dial** the charge account number.  
You receive dial tone.
4. **Dial** the number.

To charge a call in progress:



Charge



2637



1. Press the **Transfer** Key.
2. Press **Charge** Key, or enter the Call Detail Recording Charge Account FFC.
3. **Dial** the charge account number.
4. Press the **Line** (DN) Key to return to your call.

To charge a call to an account when you transfer a call:

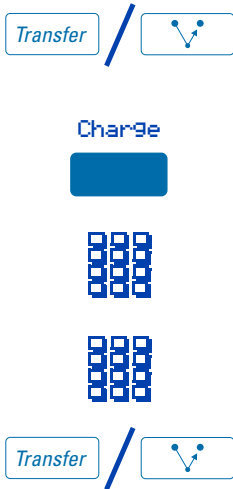

1. Press the **Transfer** Key.  
The call is placed on hold.
2. Press **Charge** Key, or enter the Call Detail Recording Charge Account FFC.
3. **Dial** the charge account number.  
You receive dial tone.
4. **Dial** the number to where the call is to be transferred.
5. Press the **Transfer** Key when you hear the telephone ring.

**Note:** You can talk privately to the person at the transfer number before you press the Transfer Key.

To charge a call to an account when you add someone to a conference call:



1. Press the **Conference** Key.  
The call is placed on hold.
2. Press **Charge** Key, or enter the Call Detail Recording Charge Account FFC.
3. **Dial** the charge account number.  
You receive dial tone.
4. **Dial** the number of the person you want to add to the conference.
5. Press the **Conference** Key.

## Charge or Force Charge a call (M3903 and M3904)

**Call Charge** allows you to charge a call to a specific account. **Forced Charge Account** allows you to charge long-distance calls from a telephone restricted to local calls.

**Note:** On the Meridian SL-100, the account code allows a user to enter a billing number. If the account code is required, the user is prompted to enter a code by a tone after the telephone number is dialed. If a user wishes to voluntarily enter an account code, then flash the switch hook and enter Account Code FAC. Flash the switch hook again to return to the call.

To charge or force charge a local or a long-distance call to an account before you dial:



Account



OK



1. Lift the **handset**.
2. Press the **Account** Key.  
The screen displays Enter account number.
3. **Dial** the charge account number. Use the **Clear** Key or **Delete** Key to edit the number. Press the **Exit** Key to leave the screen without charging the call.
4. Press the **OK** Key.
5. **Dial** the number.

To charge a call in progress:

Charge



Account



1. Press the **Charge** Key.  
The screen displays Select Charge type.
2. Press the **Account** Key.  
The screen displays Enter account number.





OK



To charge a call to an account when you transfer a call:

Trans



Account



Connect



To charge a call to an account when you add someone to a conference call:

Conf



Account



3. **Dial** the charge account number. Use the **Clear** Key or **Delete** Key to edit the number. Press the **Exit** Key to leave the screen without charging the call.
4. Press the **OK** Key. You return to your call.

1. Press the **Transfer** Key.  
The call is placed on hold.
2. Press the **Account** Key.
3. **Dial** charge account number.  
You receive dial tone.
4. **Dial** the number of the telephone where the call is to be transferred.
5. Press the **Connect** Key when you hear the telephone ring.

**Note:** You can use the **Swap** Key to talk privately to the person at the transfer number before you press the **Connect** Key.

1. Press the **Conference** Key.  
The call is placed on hold.
2. Press the **Account** Key.



3. **Dial** the charge account number.  
You receive dial tone.
4. **Dial** the number of the person you want to add to the conference.
5. Press the **Swap** Key to switch between talking with the original caller and the new caller. Press the **Connect** Key to complete the conference.

## Enhanced Override Feature

**Enhanced Override** allows you to override an active call after you have attempted a Forced Camp-on. Use Enhanced Override when you make either a simple call or a consultation call (i.e., place a call on hold and call another party).

**To use Enhanced Override:**



1. **Dial** a telephone number and receive a busy signal.
2. Press the **Override** Key or enter the Override FFC to initiate a Forced Camp-on.  
  
If either of the persons on the call disconnects at this time, you receive an overflow (fast busy/engaged) signal.
3. Press the **Override** Key again or enter the Override FFC again.

The other two persons on the call receive an override tone and a conference call is established between the three of you. If anyone disconnects, the other two persons will remain connected.

**To end the connection:**



Press the **Goodbye** Key.

**Note:** Enhanced Override is not available on the Meridian SL-100.

## Forced Camp-on

**Forced Camp-on** allows your telephone to automatically ring another telephone as soon as that telephone disconnects from its current call. Forced Camp-on allows you to camp-on both internal and external calls.

To use **Forced Camp-on**:

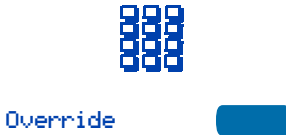

1. **Dial** a telephone number and receive a busy signal.
2. Press the **Override** Key, or enter the Override FFC, to initiate a Forced Camp-on.

**Note:** The person you called hears a tone, and you hear ring/ringback signal or busy/engaged signal (depending on the options chosen). You are now camped-on to the number you dialed.

3. When the person you called finishes their call, your telephone automatically dials the number. Both your telephone and their telephone ring.

To answer a camped-on call:



When the telephone rings, lift the **handset**.

You are connected to the camped-on caller.

**Note:** Your telephone can be programmed for either Camp-on or Call Waiting, but not both.

**Note:** Forced Camp-on is not available on the Meridian SL-100. Please refer to the Station Camp-on feature.

## Station Camp-on

---

**Station Camp-on** allows you to transfer an external call to a busy extension. When the busy extension disconnects from its current call, the transferred call will ring at the now idle extension.

**To activate Station Camp-on after answering an incoming external telephone call:**

Trans



Connect



1. Press the **Transfer** Key.  
The external party is on hold and you receive a dial tone. The screen displays **Call on hold, dial number**.
2. **Dial** the internal extension number of the telephone where the call is to be transferred.
3. On the **M3903** and **M3904** only, press the **Connect** Key.

**Note:** The person you called hears a tone, and you hear ring/ringback signal or busy/engaged signal (depending on the options chosen). The external caller hears ring/ringback signal or music.

4. Replace the **handset**.  
The external caller is now camped-on to the number you dialed.

**Note 1:** You cannot camp-on to an extension that has the Call Waiting feature configured.

**Note 2:** If the camped-on call is not accepted within a specified period of time, it returns to you or to the Attendant. Contact your network administrator to determine where, and after what period of time, unanswered calls are re-routed

## Override Feature

You can **Override** a busy signal and interrupt another call. **Note:** This feature is called Executive Busy Override on the Meridian SL-100.

To override a busy/engaged signal:



Override



or

ExeBusyOvd



1. **Dial** a telephone number and receive a busy signal.
2. Press the **Override** Key, or enter the Override FFC on the Meridian 1.

On the Meridian SL-100, press the **Executive Busy Override** Key, or enter the Busy Override FAC.

The people on the call in progress receive a tone for approximately one second; the feature connects the three of you together. A short tone repeats every sixteen seconds.

To end the connection:



Press the **Goodbye** Key.

To disconnect the third party from the called party on the Meridian SL-100:

ExeBusyOvd



Press the **Executive Busy Override** Key, or enter the Busy Override FAC again.

## Privacy Release

---

**Privacy Release** allows one or more people who share your DN to join your call.

To use **Privacy Release** while on an established call:

PrivRls



Press the **Privacy Release** Key while you are on a call.

One other person can now join the call if they press the shared Line (MADN) Key on their telephone.

**Note:** Repeat this step to allow additional persons to join the call.

To re-establish Privacy if the additional person does not join the call:

2637



Press the **DN** Key for which Privacy Release is active.

## Radio Paging

Some telephone systems can have an on-site **Radio Paging** system. This system feature allows you to page a person and stay on the line until they answer. The paged person answers the call when they enter a special Paging “Meet - me” code from any telephone. This connects the person paged to the party who paged them.

**Note:** On the Meridian SL-100, dial the Paging Feature Access Code (FAC). A network connection is established with the paging access trunk. This provides access to loudspeaker paging equipment. Automatic Pre-selection, Automatic Post-selection, and Special Radio Paging features do not apply to Meridian SL-100.

**To use Automatic Pre-selection (“Meet - me” page):**



1. Lift the **handset**.
2. **Dial** the Radio Paging FFC.  
You receive paging dial tone.
3. **Dial** the number of the party you want to page.  
You receive ringback/ring tone.

**Note 1:** The person you paged uses any telephone to enter a Radio Paging Answer code, plus their own DN. This action connects you and the person paged.

**Note 2:** If your call goes unanswered for a preset time period, you receive a continuous high pitched tone then silence. Press the Goodbye Key.

**To use Automatic Post selection:**

The called party is either busy on the telephone or away from the desk.

To page the called party there is no need to redial the number of the called party.

RadioPage



1. Press the **Radio Page** Key.  
You receive special dial tone.



### To use the Special Radio Paging features:



2. **Dial** the Radio Paging Access FFC.

You receive ringback/ring tone.

**Note 1:** The person you have paged can proceed to any telephone, enter their Radio Paging Answer code plus their own DN. This action connects you and the person paged.

**Note 2:** You receive a fifteen second, high pitched tone, then silence if the party paged does not answer the call within a preset time period. When you receive this signal, replace the handset or press the Goodbye Key.

If you carry a Radio Pager, you will receive a paging indication when another Meridian 1 telephone user access the Radio Paging system and dials your DN.

If the Radio Paging system is set up to function in "Meet - me" mode, you can use the following steps to answer the paging call from any Meridian 1 extension.

1. Lift the **handset**.
2. **Dial** the Radio Paging Answer FFC.  
You receive paging tone.
3. **Dial** your own DN.

You are connected to the paging caller.

**Note:** If the paging caller has hung up you will receive a steady high-pitched tone.



## Voice Call

The **Voice Call** feature allows you to page another person or make an announcement through someone else's telephone speaker.

To make a voice call:

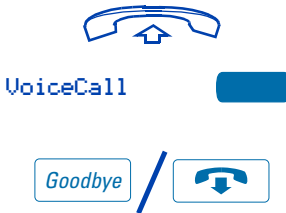

1. Lift the **handset**.
2. Press the **Voice Call** Key.
3. Make your announcement.
4. Press the **Goodbye** Key.

To respond to a voice call:



Your telephone rings once and you hear the caller's voice through your speaker. Lift the **handset**.

**Note:** On the Meridian SL-100 use the Individual Page from the Group Intercom (GIC) feature. Press the **GpIntercom** Key and dial the appropriate GIC number. After the first ring, press the **GpIntercom** Key and a one-way connection is established. Make your announcement over the speaker.

## Use the Voice Messaging control screens

The **Voice Messaging** control screens allow you to send commands while connected to your voice messaging system using the Soft Keys instead of the dial pad. **Note:** This feature is not available on the Meridian SL-100.

To use Voice Messaging controls:

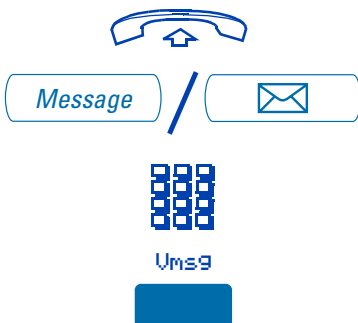

1. Lift the **handset**.
2. Press the **Message** Key.
3. Use the **dial pad** to log in to your voice mailbox.
4. Press the **Voice Message** Key.

Play



Stop



or

Last



or

Next



or

Delete



or

Skip->



or

Skip<-



Quit



5. Press the **Play** Key to play your first new message.

**Note:** Use the **More. . .** Key to view additional message options.

6. Press the **Stop** Key to pause playback of the message. Press **Play** to resume playback

or

Press the **Last** Key to go to the previous message. Press **Play** to playback the message or Press **Last** again to move to previous messages.

or

Press the **Next** Key to go to the next message. Press **Play** to playback the message or Press **Next** again to move to later messages.

or

Press the **Delete** Key to delete the current message.

or

Press the **Skip Forward** Key to advance three seconds in the current message.

or

Press the **Skip Backward** Key to rewind three seconds in the current message.

7. Press the **Quit** Key at any time to exit your voice messaging system. Your telephone is now ready to make or receive new calls.

## Hospitality features

These hospitality features are intended for hotel operations use.

**Note:** With the exception of Automatic Wake-Up, hospitality features are not available on the Meridian SL-100.

### Automatic Wake-Up

Although normally used as a hotel feature, **Automatic Wake-Up** may be useful to business users who require a timed reminder call feature. From your telephone you may program the Meridian 1 system to automatically place a call to you at a predetermined time. When you answer the call, you hear recorded music for up to thirty seconds followed by a pre-recorded announcement, or the attendant.

**To enter the time for a wake-up call:**



1. Lift the **handset**.
2. **Dial** the Automatic Wake-Up Activate FFC on the Meridian 1 or the Wake-Up Request FAC on the Meridian SL-100.
3. **Dial** the wake-up time in a 24-hour format (hhmm).
4. Press the **Goodbye** Key.

**Note:** On the Meridian SL-100, after you enter the FAC, you receive a second dial tone. Enter four consecutive digits to specify an hour and minute. The reminder time is specified in 24 hour format. (i.e., for 6:00 PM, input 1800.) You receive a confirmation tone.

**To cancel a wake-up call:**



1. Lift the **handset**.
2. **Dial** the Automatic Wake-Up Deactivate FFC on the Meridian 1 or the Wake-Up Cancel FAC on the Meridian SL-100.



3. Press the **Goodbye** Key.

**Note:** On the Meridian SL-100, after you enter the FAC, you receive a confirmation tone.

To verify the time for the wake-up call:



1. Lift the **handset**.

2. **Dial** the Automatic Wake-Up Verify FFC.

3. **Dial** the wake-up time in a 24 hour time format (hhmm). If it is correct, you receive a confirmation tone.

**Note:** This feature is not available on the Meridian SL-100. To change the specified time for a wake-up call on the Meridian SL-100, you must first deactivate the feature and then activate the feature with a new request.



4. Press the **Goodbye** Key.

**Note:** In 24-hour time format, 7:30 AM is entered as 0730; 9:45 PM is 2145.

## Message Registration

**Message Registration** allows you to read, change, or reset meters that log your hotel telephone calls.

### To read meters:

MsgReg



1. Press the **Message Registration** Key.
2. **Dial** the room Directory Number (DN).

MsgReg



3. Press the **Message Registration** Key.

### To change a meter:

MsgReg



1. Press the **Message Registration** Key.
2. **Dial** the room Directory Number (DN).
3. **Dial** the correct meter count.

MsgReg



4. Press the  Key.
5. Press the **Message Registration** Key

### To reset a meter to zero:

MsgReg



1. Press the **Message Registration** Key.
2. **Dial** the room Directory Number (DN).
3. Press the  Key.

MsgReg



4. Press the **Message Registration** Key.

## Maid Identification

---

**Maid Identification** makes it easier to keep track of which maids clean which rooms. The maid enters the information from the telephone in each room.

**To enter cleaning status:**

RoomStatus



RoomStatus



1. Press the **Room Status** Key.
2. **Dial** the Directory Number (DN) for the room for which the cleaning status is being changed.
3. **Dial** one of the following cleaning status codes:

= cleaning requested

= cleaning in progress

= room cleaned

= room passed inspection

= room failed inspection

= cleaning skipped

= not for sale

You receive interrupted dial tone.

4. Press the  Key.
5. **Dial** the Maid ID. If you dial the wrong Maid ID, press the  Key and redial the ID.
6. Press the **Room Status** Key.

## Room Status

---

**Room Status** lets you read the status of a room using the display.

To read the status of a room:

RoomStatus



1. Press the **Room Status** Key.
2. **Dial** the Directory Number (DN) for the room. The DN is displayed followed by a two digit code.

The first digit indicates the occupancy status:

∅ = room vacant

1 = room occupied

The next digit indicates the cleaning status of the room:

1 = cleaning requested

2 = cleaning in progress

3 = room cleaned

4 = room passed inspection

5 = room failed inspection

6 = cleaning skipped

7 = not for sale

RoomStatus



3. Press the **Room Status** Key.

# Meridian SL-100 CLASS Features

## Anonymous Caller Rejection

---

The **Anonymous Caller Rejection** feature allows you to reject incoming calls on your line (DN) for which calling name and number have been intentionally blocked. Only calls in which the information has been blocked are rejected. Check with your network administrator regarding the availability of this feature.

**To activate Anonymous Caller Rejection:**



1. Lift the **handset**.
2. **Dial** the Anonymous Caller Rejection Activate FAC.

A recording or confirmation tone informs you that Anonymous Caller Rejection is activated.

**To deactivate Anonymous Caller Rejection:**



1. Lift the **handset**.
2. **Dial** the Anonymous Caller Rejection Deactivate FAC.

A recording or confirmation tone informs you that Anonymous Caller Rejection is deactivated.

**Note:** Availability of this feature is dependent upon your Meridian SL-100 system software and network connections.



## Automatic Callback

The **Automatic Callback** feature allows you to enter a Feature Access Code (FAC) that will automatically set up a call to the last Directory Number (DN) you dialed on your individual line (DN) regardless of whether the call was answered, unanswered, or busy. Check with your network administrator regarding the availability of this feature.

**To activate Automatic Callback after you have dialed a number:**



2498



**To cancel Automatic Callback:**

2498



1. Press the **Goodbye** Key to disconnect the call.
2. Press the **Line** (DN) Key.
3. **Dial** the Automatic Callback Activate FAC and follow the instructions provided by the announcement.
4. Press the **Goodbye** Key.  
When both your line and the called party's line are idle, your telephone will ring.
5. When the telephone rings, lift the **handset**.  
You will hear normal ringback/ring tone.

1. Press the **Line** (DN) Key.
2. **Dial** the Automatic Callback Deactivate FAC.

**Note:** Availability of this feature is dependent upon your Meridian SL-100 system software and network connections.

## Automatic Recall

---

The **Automatic Recall** feature allows you to enter a Feature Access Code (FAC) that will automatically set up a call to the last incoming call on your Directory Number (DN). Check with your network administrator regarding the availability of this feature.

### To activate Automatic Recall:

2498



1. Press the **Line** (DN) Key.
2. **Dial** the Automatic Recall Activate FAC.

An announcement may provide additional instructions or announce the number of the last incoming call and provide you with a choice of whether or not to continue with the recall.

If you continue the recall, the Automatic Recall feature will dial the last number that called you. If the number is busy, Automatic Recall will continue trying until the line is idle.

When both your line and the called party's line are idle, your telephone will ring.

3. When the telephone rings, lift the **handset**.

You will hear normal ringback/ring tone.



### To cancel Automatic Recall:

2498



1. Press the **Line** (DN) Key.
2. **Dial** the Automatic Recall Deactivate FAC.

**Note:** Availability of this feature is dependent upon your Meridian SL-100 system software and network connections.

## Customer Originated Trace

The **Customer Originated Trace** feature allows you to activate an immediate trace of the last incoming call to your Directory Number (DN) without requiring prior approval and manual intervention by your network administrator. Customer Originated Trace may be activated on a per-call basis. This feature may be activated using a feature key or by using a Feature Access Code (FAC). Check with your network administrator regarding the availability of this feature.

**To activate Customer Originated Trace after receiving a harassing or prank telephone call:**



2498



CustOrigTr



1. Press the **Goodbye** Key to disconnect from the harassing or prank telephone call.
2. Press the **Line** (DN) Key.
3. Press the **CustOrigTr** Key, or dial the Customer Originated Trace FAC.

An announcement will inform you whether or not the call was successfully traced.

4. Press the **Goodbye** Key to disconnect .  
The feature is automatically deactivated.

Contact your network administrator for follow-up actions.

**Note:** Availability of this feature is dependent upon your Meridian SL-100 system software and network connections.

## Calling Name and Number Delivery Blocking

---

The **Calling Name and Number Delivery Blocking** feature allows you to control the display of your Directory Number (DN), or your name and DN, on the display of the party you are calling. This feature is available on a per-call basis. Instead of your name and/or telephone number being displayed, the word "Private" is displayed on the called party's telephone display. Check with your network administrator regarding the availability of this feature.

**To activate Calling Name and Number Delivery Blocking:**

2498



1. Press the **Line** (DN) Key.
2. **Dial** the Calling Name and Number Delivery Blocking FAC.  
Listen for confirmation tone, or an announcement, followed by dial tone.
3. **Dial** the telephone number.

**Note:** Availability of this feature is dependent upon your Meridian SL-100 system software and network connections.

## Selective Call Forward

---

The **Selective Call Forward** feature allows you to program a list of up to 31 Directory Numbers (DNs) from which calls to your DN will be rejected or blocked. Incoming calls from DN's that are on the list will be routed to announcement, or other call treatment may be assigned. Check with your network administrator regarding the availability of this feature.

**To activate Selective Call Forward:**

2498



1. Press the **Line** (DN) Key.
2. **Dial** the Selective Call Forward FAC.  
Listen to the announcement for instructions on how to turn on, turn off, enter, change, or review your Selective Call Forward list.

**Note:** Availability of this feature is dependent upon your Meridian SL-100 system software and network connections.

## Telephone display

This section summarizes the display features of the **M3902**, **M3903**, and the **M3904**. Idle display is shown in the following figures.

### M3902 display

The **M3902** display gives call status and feature information.

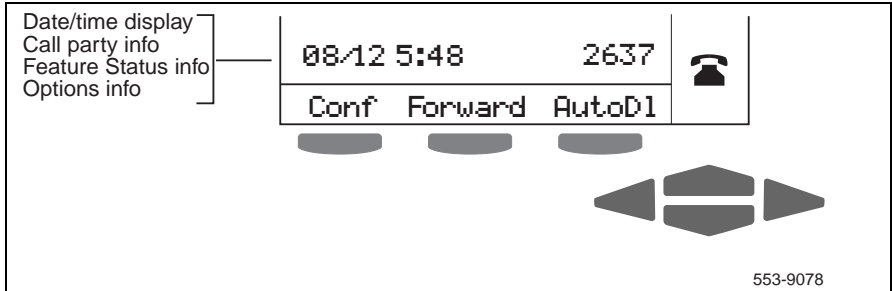

### M3903 display

The upper portion of the display on the **M3903** gives call status information, the lower display area contains a single line which displays feature information. If you are viewing a list that contains more than one item, you must use the Navigation Keys to scroll through the list. When the item you want appears, press the Select Key.

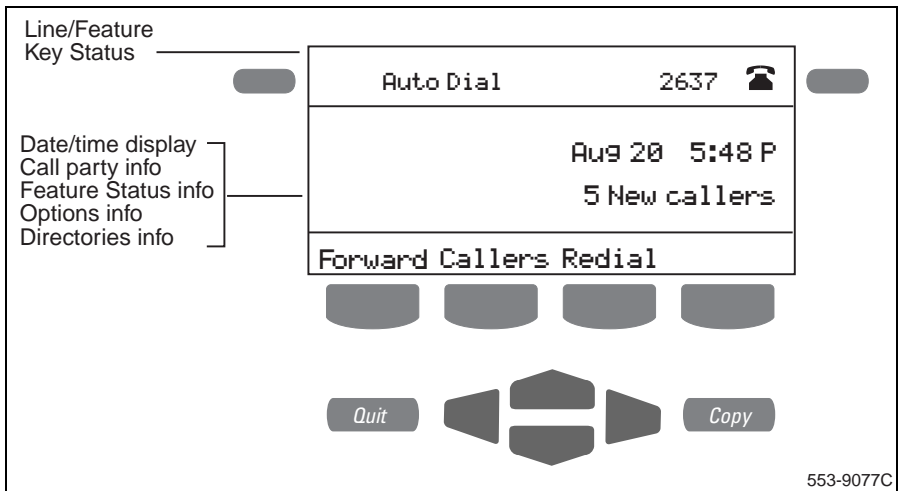

## M3904 display

The upper portion of the display on the **M3904** gives call status information, the lower display area is a three line feature information display.

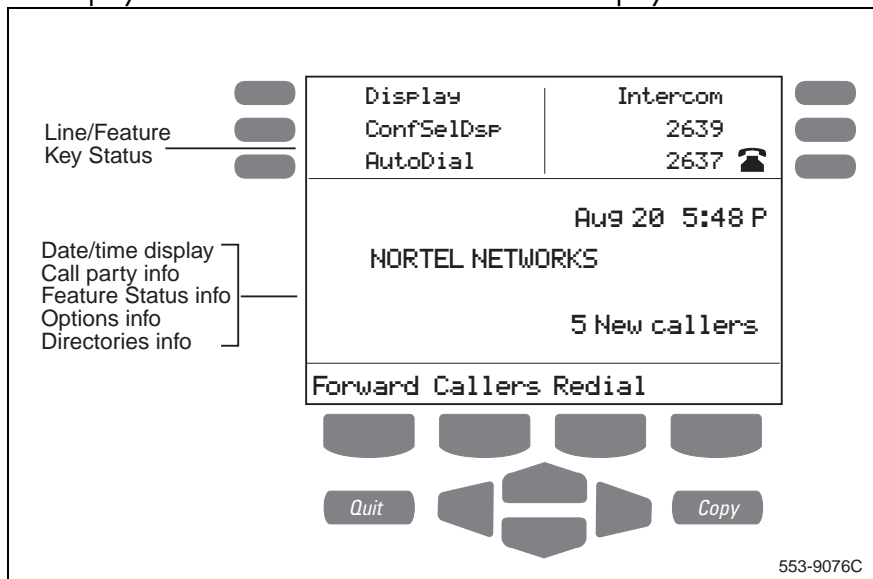

**Note:** Refer to "Your Telephone's Controls" on page 5 and for more information on display and specialized key information.

## Options List

The **Options List** (available on the **M3902**, **M3903**, and **M3904**) allows you to customize certain characteristics of your phone. Screen prompts take you step-by-step through procedures and keep you informed on the status of the following settings: Language, Change feature key label, Screen contrast, Volume adjustment, Ring type, Call log options, Live dial pad, Preferred name match, Area code set-up, Call timer enable, Date/time format, Key click enable, Headset port on call, Headset port external alerter and recorder interface, Call indicator light, On hook default path, and Display diagnostics.

Most of the options are available to you on the **M3902**, **M3903**, and **M3904**. Some of the options are available only if turned on by your network administrator; others are designed for specific models in the M3900 series.

**To change any option's setting:**



Select



Done



Quit



or



1. Press the **Options** Key.
2. Use the **Navigation** Keys to scroll up or down through the options list.
3. Press the **Select** Key when the desired option is highlighted.
4. Change the option's settings. Refer to the following pages for details. The display also provides you with information to adjust your selection.
5. Press the **Done** Key to save your changes.
6. Press the **Quit** Key or **Options** Key to exit.

**Note:** If you press the **Quit** Key or **Options** Key before you press the **Done** Key, you exit the Options List without saving your changes.

## Select a language

The display is available in multiple languages. After you select **LANGUAGE...** from the **Options List** menu,



Deutsch

Select



Press the **Done** Key to save changes. Press the **Quit** Key or **Options** Key to exit.

## Change a Feature Key label (M3902)

You can change the labels on the three feature keys located at the bottom of the display on the **M3902**.

To change a Feature Key label:



Change feature key label

Select



Select



1. Use the **Navigation** Keys to highlight the desired language (e.g., German).

2. Press the **Select** Key.

1. Use the down **Navigation** Key to highlight **Change feature key label**.

2. Press the **Select** Key.

This action takes you to the **Feature Key** menu and highlights **Edit a feature key label**.

3. Press the **Select** Key again.

The prompt asks you to select the key you want to change.

4. Use the **Navigation** Keys to highlight the label you want to change, (e.g., **AutoD1**).



Select



5. Press the **Select** Key.
6. Press the **Dial Pad** Key that is printed with the first letter in your new label. Press the key until the correct character appears.
7. Repeat step 6 until you have changed the entire label.

Press the **Done** Key to save changes. Press the **Options** Key to exit.

**Note 1:** For a detailed example of using the dial pad to enter text into your M3900 Series telephone, please see “Add a Personal Directory entry” on page 102.

**Note 2:** You cannot change the label on your primary DN.

**Note 3:** Use the **Case** Key to change the case of the letter, as needed. You can use the **Delete** Key to delete one character, or the **Clear** Key if you want to delete the entire label.

**Note 4:** Press the **Up Navigation** Key to access special characters you may want to include in the label. Use the **Navigation** Keys to locate the character you want to include. Press the **Select** Key to choose the highlighted character. Press the **Return** Key to return to label entry without selecting a special character.

**To restore all key labels:**



Restore all key labels

Select



Restore



1. Use the down **Navigation** Key to highlight **Restore all key labels**.
2. Press the **Select** Key.  
The display asks you to verify that you want to restore all labels.
3. Press the **Restore** Key.

Press the **Done** Key to return to the **Options List** menu. Press the **Options** Key to exit.

## Change a Feature Key label (M3903 and M3904)

You can change the name on the Programmable Line (DN)/Feature Keys (self-labeled). These keys are located on both sides of the top portion of the display area on the **M3903** and **M3904**.

To change a Feature Key label:



Change feature key label

Select



Select



AutoDial



1. Press the down **Navigation** Key once to highlight Change feature key label.

2. Press the **Select** Key.

This action takes you to the **Feature Key** menu and highlights Change feature key label.

3. Press the **Select** Key again.

The prompt asks you to select the key you want to change.

4. Press the **Programmable Line (DN)/Feature** Key whose label you want to change, (e.g., AutoDial).

5. Press the **Dial Pad** Key that is printed with the first letter in your new label. Press the key until the correct character appears.

6. Repeat step 5 until you have changed the entire label.

Press the **Done** Key to save changes. Press the **Quit** Key or **Options** Key to exit.

**Note 1:** For a detailed example of using the dial pad to enter text into your M3900 Series telephone, please see "Add a Personal Directory entry" on page 102.

**Note 2:** You cannot change the label on your primary DN. Press the **Shift** Key if the label you want to change in on the second layer of the **Programmable Line (DN)/Feature** Keys (self-labeled).

**Note 3:** Use the **Case** Key to change the case of the letter, as needed. You can use the **Delete** Key to delete one character, or the **Clear** Key (**M3903**) if you want to delete the entire label. On the **M3903** you may use the **Space** Key to enter a space or the **Restore** Key to restore the label to the default value.

**Note 4:** Press the **Up Navigation** Key or the **Chars** Key (**M3903**) to access special characters you may want to include in the label. Use the **Navigation** Keys to locate the character you want to include. Press the **Select** Key to choose the highlighted character. Press the **Return** Key to return to label entry without selecting a special character.

#### To restore one key label (M3904):



Restore one key label

Select



Purchasing



1. From the **Feature Key** menu, use the down **Navigation** Key to highlight **Restore one key label**.
2. Press the **Select** Key.
3. Press the **Programmable Line (DN)/Feature** Key (self-labeled) that you want to restore to the original label (e.g., **Purchasing**).

Press the **Done** Key to return to the **Options List** menu. Press the **Quit** Key or **Options** Key to exit.

#### To restore all key labels:



Restore all key labels

Select



Restore



1. Use the down **Navigation** Key to highlight **Restore all key labels**.
2. Press the **Select** Key.  
The display asks you to verify that you want to restore all labels.
3. Press the **Restore** Key.

Press the **Done** Key to return to the **Options List** menu. Press the **Quit** Key or **Options** Key to exit.

## Adjust Screen contrast

The **Screen contrast** option allows you to adjust the contrast of the display on your telephone. After you select Screen contrast from the **Options List** menu;



From the **Contrast** screen, press the **Lower** Key to decrease the display contrast level, or press the **Higher** Key to increase the display contrast level.

Press the **Done** Key to save changes. Press the **Quit** Key or **Options** Key to exit.

## Adjust volume

**Note:** After you select Volume adjustment. . . from the **Options List** menu, a list of adjustable items for your telephone model appears. It is recommended that you adjust these parameters while you are on a telephone call so that you can judge the impact of the changes you are making.

To adjust the Ringer volume:

Ringer

Lower or Higher

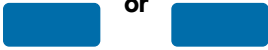

1. Select **Ringer** from the **Volume** menu.
2. Press the **Lower** Key to decrease the ringer volume, or press the **Higher** Key to increase the ringer volume.

Press the **Done** Key to save changes. Press the **Quit** Key or **Options** Key to exit.

Use the procedure above to adjust the volume on the following items:

Buzzer

Headset listen

Speaker

Headset talk

Handset listen

Headset sidetone

Handsfree listen

**Note 1:** Headset listen is adjustable on the **M3903** and **M3904** only.

**Note 2:** Headset talk and Headset sidetone are adjustable on the **M3904** only.

**Note 3:** Headset sidetone (**M3904** only) is the sound of your own voice that you hear in the headset speaker.

## Choose Ring type

The **Ring type** option allows you to choose from among the various ringing sounds available for your telephone model. After you select **RING TYPE...** from the **Options List** menu;



Ring type 3

Play



Select



1. Use the **Navigation** Keys to scroll through the list of ring types.
2. Press the **Play** Key to sample a ring tone.
3. Press the **Select** Key to activate the desired ring type (**M3903** and **M3904**).

Press the **Done** Key to save changes. Press the **Quit** Key or **Options** Key to exit.

## Select Call Log options

The **Call Log options** (available on the **M3903** and **M3904**) provide a choice of logging all incoming calls, logging only the unanswered calls, or not logging any calls. The Call Log holds up to 10 different incoming entries for the **M3903** and up to 100 for the **M3904**. After you select **Call log options** from the **Options List** menu;



Log all calls

or

Log unanswered calls

From the **Log options** menu, use the **Navigation** Keys to highlight and select either:

Log all calls

or

Log unanswered calls

**Note:** New call indication must be set to **On**, if you want Call Log notification.

Press the **Done** Key to save selection. Press the **Quit** Key or **Options** Key to exit.

## Use Live dial pad

---

The **Live dial pad** option (available on the **M3904**) allows you to press any dial pad key to automatically access a dial tone. After you select **Live dial pad** from the **Options List** menu;



From the **Live dialpad** screen, press the **On** Key to turn on Live dial pad, or press the **Off** Key to turn off Live dial pad.

Press the **Done** Key to save changes. Press the **Quit** Key or **Options** Key to exit.

## Select Preferred name match

---

The **Preferred name match** option (available on the **M3904**) displays the names of incoming and outgoing callers as stored in your Personal Directory, if the telephone number matches the one stored in your directory. This option allows you to personalize the displayed names for incoming and outgoing calls. After you select **Preferred name match** from the **Options List** menu;



From the **Name match** screen, press the **On** Key to turn on Preferred name match, or press the **Off** Key to turn off Preferred name match.

Press the **Done** Key to save changes. Press the **Quit** Key or **Options** Key to exit.

## Set up area code

---

Using the **Area code set-up** option (available on the **M3904**) causes the Callers List and Calling Line ID (CLID) display show the number/extension followed by the area code/prefix in parenthesis. This makes it easier to identify local calls and internal calls. You can define up to three codes. After you select **Area code set-up** from the **Options List** menu

1st Code: 408  
2nd Code:  
3rd Code:

Use the **Navigation** keys to place your cursor in the first line and enter an **area/country code** of your choice.

**Note:** You can enter up to three codes of your choice.

Press the **Done** Key to save changes. Press the **Quit** Key or **Options** Key to exit.

## Enable Call timer

---

The **Call timer enable** option measures how long you are on each call. After you select **Call timer enable** from the **Options List** menu;



From the **Call timer** screen, press the **On** Key to turn on the Call timer, or press the **Off** Key to turn off the Call timer.

Press the **Done** Key to save changes. Press the **Quit** Key or **Options** Key to exit.

## Select Date/time format

---

There are eight **Date/time formats**. Four formats are based on the 12 hour clock and four are based on the 24 hour clock. After you select **Date/time format...** from the **Options List** menu;



Use the **Navigation** Keys to scroll through the eight formats. The sample formats appear on the upper right side of the display area.

Format 3

Press the **Done** Key to select the highlighted format. Press the **Quit** Key or **Options** Key to exit.

## Enable Key click

---

The **Key click** option causes the handset or speaker to produce a clicking sound when you press the telephone keys. After you select **Key click enable** from the **Options List** menu;



From the **Key click** screen, press the **On** Key to turn on Key click, or press the **Off** Key to turn off Key click.

Press the **Done** Key to save changes. Press the **Quit** Key or **Options** Key to exit.

## Use Headset port on call

---

The **Headset port on call** option (available on the **M3904**) requires that a lamp-type accessory be connected to the headset port. When the Headset port on call option is activated and the user is on a call, the lamp lights providing an indication that a call is in progress. After you select **Headset port on call** from the **Options List** menu;



From the **On call** screen, press the **On** Key to turn on Headset port on call, or press the **Off** Key to turn off Headset port on call.

Press the **Done** Key to save changes. Press the **Quit** Key or **Options** Key to exit.

**Note:** Additional equipment is required to implement this option. For more information please contact your Nortel Networks distributor.

## Activate Headset port external alerter

---

When the **Headset port external alerter** option (available on the **M3904**) is activated, it supports a visual or audible alerter and/or recorder device. This device plugs into the Headset port, which is located on the bottom of the telephone. After you select **Headset port ext. alerter** from the **Options List** menu;



From the **External alerter** screen, press the **On** Key to turn on Headset port external alerter, or press the **Off** Key to turn off Headset port external alerter.

Press the **Done** Key to save changes. Press the **Quit** Key or **Options** Key to exit.

**Note:** Additional equipment is required to implement this option. For more information please contact your Nortel Networks distributor.

## Use Call indicator light

---

The incoming call indicator light can be controlled on the **M3904**. After you select **Call indicator light** from the **Options List** menu;



From the **Indicator** screen, press the **On** Key to turn on Call indicator light, or press the **Off** Key to turn off Call indicator light.

Press the **Done** Key to save changes. Press the **Quit** Key or **Options** Key to exit.



## Set On-hook default path

---

The **On-hook default path** option (available on the **M3903** and **M3904**) automatically opens the voice path on either a Headset (connected to the headset jack) or on Handsfree when you press a Line (DN) Key. After you select **On hook default path** from the **Options List** menu;



Handsfree selected

or

Headset selected

From the **On hook path** menu, use the **Navigation** Keys to highlight and select either:

Handsfree selected

or

Headset selected

Press the **Done** Key to save selection. Press the **Quit** Key or **Options** Key to exit.

**Note:** Refer to “Headsets” on page 128 for information on recommended headset types for your telephone.

## Display diagnostics

---

The **Display diagnostics** option tests the functionality of your telephone’s display screen and indicator lights. This option also provides information on the firmware currently in use on your M3900 series telephone. After you select **Display diagnostics** from the **Options List** menu;



Use the up or down **Navigation** Key to scroll through the list and view the changing display screens.

Press the **Done** Key to return to the **Options List** menu. Press the **Quit** Key or **Options** Key to exit.

## Activate Group Listening

---

The **Group Listening** feature enables you to talk on the handset to one party while other people listen to the conversation on your telephone's speaker. The network administrator must enable this feature. After you select **GROUP LISTENING** from the **Options List** menu;



From the **Group listening** screen, press the **On** Key to turn on Group listening, or press the **Off** Key to turn off Group listening.

Press the **Done** Key to save changes. Press the **Quit** Key or **Options** Key to exit.

**Note 1:** The Group listening selection will not appear in the Options List menu of your telephone unless this feature has been enabled by your network administrator.

**Note 2:** You must let the other party know when others are listening to the conversation. This feature does not have a tone to inform the party on the other end of the call that the conversation is being monitored.

# Call Log and Personal Directory display and navigation

## M3903 Call Log display and navigation

The **M3903** information display shows one item at a time. Use the Navigation Keys to scroll through the list. When the item you want appears, press the Select Key. The figure below shows the status once you log into the Call Log. The **M3903** Call Log contains a Callers List and a Redial list. The **M3903** does not have a Personal Directory.

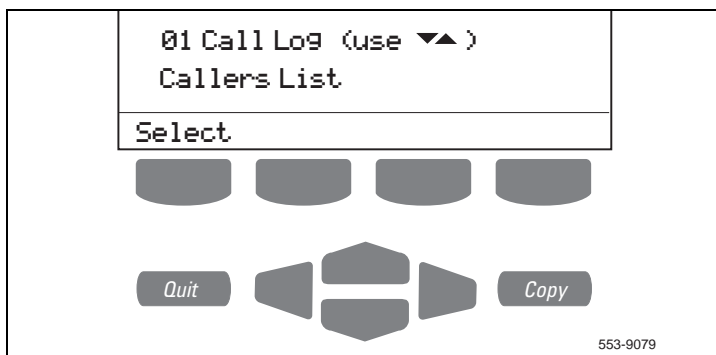

## Access your Callers List or Redial List (M3903)

To access the M3903 Call Log using the Call Log Key:

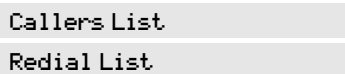

Select



1. Press the **Call Log** Key.
2. Use the **Navigation** Keys to highlight the list that you want to view.
3. Press the **Select** Key.

To access the M3903 Callers List or Redial List using a Context Sensitive Soft Key or a Programmable Feature Key:



Press the **Callers** Key to access the Callers List, or press the **Redial** Key to access the Redial List.

To exit the M3903 Call Log:

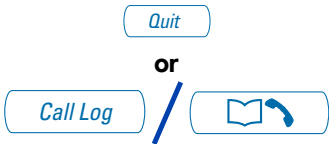

Press the **Quit** Key or the **Call Log** Key to exit.

## M3904 Personal Directory and Call Log display and navigation

With the M3904's display, you can view three lines of information. The figure below shows the status once you log into the directory.



## Access your Personal Directory, Callers List, or Redial List (M3904)

To access the M3904 Directory/Log:

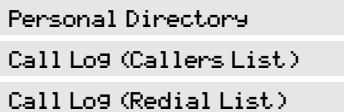

Select



To access the M3904 Callers List or Redial List using a Context Sensitive Soft Key or a Programmable Feature Key:



To exit the M3904 Directory/Log:

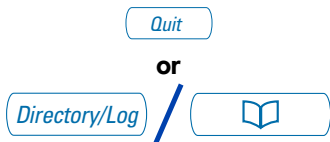

1. Press the **Directory/Log** Key.

**Note:** When you press the **Directory/Log** Key, your Personal Directory is automatically selected. At this point, you may begin searching the directory using the telephone's dial pad. See "Search for an entry" on page 109.

2. Use the **Navigation** Keys to highlight the Personal Directory or the Call Log that you want to view.
3. Press the **Select** Key.

Press the **Callers** Key to access the Callers List, or press the **Redial** Key to access the Redial List.

Press the **Quit** Key or the **Directory/Log** Key to exit.

## Call Log and Personal Directory password protection (M3903 and M3904)

You can password protect your Callers List and Redial List. Your password also protects your Personal Directory (**M3904 only**). If password protection is activated, you will be asked to enter your password each time you press the Call Log Key (**M3903**) or Directory/Log Key (**M3904**).

To enable password protection:



or



1. Press the **Call Log** Key (**M3903**) or the **Directory/Log** Key (**M3904**).
2. From the **Call Log** menu (**M3903**) or **Directories** menu (**M3904**), use the **Navigation** Keys to highlight Password Administration.

### Password Administration

Select



Select



On



Enter



3. Press the **Select** Key. The **Password Administration** menu appears with Password enabled: OFF highlighted.
4. Press the **Select** Key again to select Password enabled: OFF.
5. Press the **On** Key to enable password protection.
6. **Dial** the password.
7. Press the **Enter** Key.
8. **Dial** the password again to confirm your password.

Enter



Done



Quit

or



or



To disable Personal Directory password:



or



Enter



Password Administration

Select



9. Press the **Enter** Key.
10. Press the **Done** Key to save changes.
11. Press the **Quit** Key or the **Call Log** Key (M3903) or the **Directory/Log** Key (M3904) to exit.

1. Press the **Call Log** Key (M3903) or the **Directory/Log** Key (M3904).
2. **Dial** the password.
3. Press the **Enter** Key.
4. Use the **Navigation** Keys to highlight Password Administration.
5. Press the **Select** Key. The **Password Administration** menu appears with Password enabled: ON highlighted.

Select



Off



Done



Quit

or



or



6. Press the **Select** Key again to select Password enabled: ON.
7. Press the **Off** Key to disable password protection.
8. Press the **Done** Key to save changes.
9. Press the **Quit** Key or the **Call Log** Key (M3903) or the **Directory/Log** Key (M3904) to exit.



## Call Log

The **Call Log** (available on the **M3903** and **M3904**) records the name and number of incoming and outgoing calls and can be password protected on the **M3904**. You can activate Call Log to record all calls, record only the unanswered calls, or record no incoming calls.

The **Callers List** stores incoming calls, and the **Redial List** stores outgoing calls in order of date and time received/made. The oldest call is stored at the top of the list. The newest call is stored at the bottom of the list.

The **M3904** Call Log list holds up to 100 entries for incoming and 20 entries for outgoing calls. The **M3904** can copy a number from the Callers List or Redial List and store it in the Personal Directory.

The **M3903** Call Log list holds up to 10 entries for incoming and 5 entries for outgoing calls.

### Access and use the Callers List (M3903)

To access the Callers List using the Call Log Key:



Callers List

Select



New



or

Old



1. Press the **Call Log** Key.
2. Use the **Navigation** Keys to highlight Callers List.
3. Press the **Select** Key.
4. Press the **New** Key to go to the top of the new calls list, or press the **Old** Key to go to the top of the old calls list.

To access the Callers List using a Context Sensitive Soft Key or a Programmable Feature Key:

Callers



Press the **Callers** Key.

If there are new calls, you are presented with the first call in the new calls list.

If there are no new calls, you are presented with the first call in the old calls list.

To make a call from the Callers List:



2498

Dial



To exit the Callers List without making a call:

Quit

or

Call Log



Press the **Quit** Key or the **Call Log** Key to exit.

1. Use the **Navigation** Keys to highlight the number you want to call.

**Note 1:** If you are calling an external or long distance number, you will need to edit the number to add the access codes required by your system to make an external or long distance call.

**Note 2:** Press the **Pause** Key to insert a 1.5 second pause in the dialing string.

2. Press the **Dial** Key to call the number selected. You leave the Callers List when you make the call.

## Access and use the Callers List (M3904)

To access the Callers List using the Directory/Log Key:

Directory/Log



Call Log (Callers List)

1. Press the **Directory/Log** Key.
2. Use the **Navigation** Keys to highlight Call Log (Callers List).

Select



New

Old

or



To access the Callers List using a Context Sensitive Soft Key or a Programmable Feature Key:

Callers



To make a call from the Callers List:



2498

Dial



To exit the Callers List without making a call:

Quit

or

Directory/Log



3. Press the **Select** Key.
4. Press the **New** Key to go to the top of the new calls list, or press the **Old** Key to go to the top of the old calls list.

Press the **Callers** Key.

If there are new calls, you are presented with the first call in the new calls list.

If there are no new calls, you are presented with the first call in the old calls list.

1. Use the **Navigation** Keys to highlight the number you want to call.

**Note 1:** If you are calling an external or long distance number, you will need to edit the number to add the access codes required by your system to make an external or long distance call.

**Note 2:** Press the **Pause** Key to insert a 1.5 second pause in the dialing string.

2. Press the **Dial** Key to call the number selected. You leave the Callers List when you make the call.

Press the **Quit** Key or the **Directory/Log** Key to exit.

## Redial List

The **Redial List** (available on the **M3903** and **M3904**) records your last 20 (**M3904**) or 5 (**M3903**) outgoing calls and can be password protected. On the **M3904**, you can copy these numbers to your Personal Directory.

### Access and use the Redial List (M3903)

To access the Redial List using the Call Log Key:



Redial List

Select



To access the Redial List using a Context Sensitive Soft Key or a Programmable Feature Key:

Redial



To make a call from the Redial List:



5551212

Dial



1. Press the **Call Log** Key.
2. Use the **Navigation** Keys to highlight Redial List.
3. Press the **Select** Key.

Press the **Redial** Key. You are presented with the most recently dialed number.

1. Use the **Navigation** Keys to highlight the number you want to call.
- Note:** If you are calling an external or long distance number, be sure that the appropriate access codes are included.
2. Press the **Dial** Key. Your call is automatically dialed and you exit the Redial list.

## Access and use the Redial List (M3904)

To access the Redial List using the Directory/Log Key:



Call Log (Redial List)

Select



To access the Redial List using a Context Sensitive Soft Key or a Programmable Feature Key:

Redial



To make a call from the Redial List:



5551212

Dial



1. Press the **Directory/Log** Key.
2. Use the **Navigation** Keys to highlight Call Log (Redial List).
3. Press **Select**.

Press the **Redial** Key. You are presented with the most recently dialed number.

1. Use the **Navigation** Keys to highlight the number you want to call.  
**Note:** If you are calling an external or long distance number, be sure that the appropriate access codes are included.
2. Press the **Dial** Key. Your call is automatically dialed and you exit the Redial List.

## Access and use the Personal Directory

The Personal Directory (available on the **M3904**) provides a personalized directory of names and telephone numbers. The Personal Directory allows you to add, delete, search, and edit entries and can be password protected. The Personal Directory holds up to 100 entries (an entry is one name and one telephone number). You can add a directory entry by copying the entry from your Callers List or Redial List. You can also add entries with the “AddNew” Key or by using the Personal Directory PC Utility application. The Personal Directory PC Utility uses an accessory cartridge to connect your PC and your **M3904** telephone. You can create a directory on your Personal Computer and transfer it to your **M3904** telephone.

### Access the Personal Directory

---

Directory/Log



Select



1. Press the **Directory/Log** Key.
2. Press the **Select** Key in the **Directories** menu to select Personal Directory.

**Note:** When you press the **Directory/Log** Key, your Personal Directory is automatically selected. At this point, you may begin searching the directory using the telephone’s dial pad. See “Search for an entry” on page 109.

### Add a Personal Directory entry

---

After accessing your Personal Directory:

AddNew



1. Press the **Add New** Key.
2. **Dial** the new name.

**Example:**

To enter the name and telephone number for **Chris**:

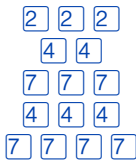

Next



Done



1. **Dial** the name using the key pad.

**Note:** Press the **Up Navigation** Key to access special characters you may want to include in the name. Use the **Navigation** Keys to locate the character you want to include. Press the **Select** Key to choose the highlighted character. Press the **Return** Key to return to name entry without selecting a special character.

2. Press the dial pad **key** with the desired letter repeatedly until that letter appears on the display.
3. Press the **right arrow** key to go to the next letter.

**Note:** The cursor automatically advances to the next position, if a different-from-last key is pressed, or after a short pause.

4. Press the **Next** Key.
5. Use the **dial pad** to enter the telephone number associated with the name entered above.

**Note 1:** The number may contain up to 31 digits.

**Note 2:** Press the **Pause** Key to insert a 1.5 second pause in the dialing string.

**Note 3:** If you are adding an external or long distance number, be sure to include the access codes required by your system to make an external or long distance call.

6. When you have finished entering all of the digits, press the **Done** Key to save the changes.

Quit

or

Directory/Log



7. Press the **Quit** Key or the **Directory/Log** Key to exit.

## Add an incoming call

Copy



Dirctry



Next



or

Clear



Next



Done



1. Press the **Copy** Key.  
The displays shows the message **COPY to.**
2. Press the **Directory** Key.
3. Press **Next** to copy the incoming call without editing the name. Edit the number, if required (see notes for step 4) and go to step 5.  
**or**  
Press **Clear** to make changes to the name before saving. Add the name using the **dial pad**, **Delete**, and **Case** Keys as needed.
4. Press the **Next** Key. Make changes to the telephone number if required.  
**Note 1:** The number may contain up to 31 digits.  
**Note 2:** Press the **Pause** Key to insert a 1.5 second pause in the dialing string.  
**Note 3:** If you are adding an external or long distance number, be sure to include the access codes required by your system to make an external or long distance call.
5. Press the **Done** Key to save the entry in your directory.



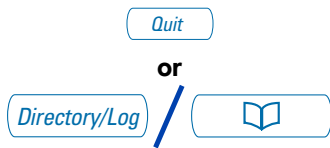

6. Press the **Quit** Key or the **Directory/Log** Key to exit.

**Note:** You can edit the name or number before or after you save to the directory.

## Add an outgoing call



Dirctry



Next



Done

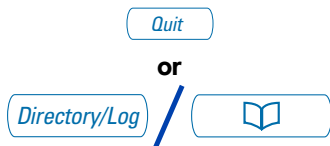

1. After the person you called answers, press the **Copy** Key.  
The displays shows COPY to.
2. Press the **Directory** Key.
3. Add the name, using the **dial pad**, **Delete**, and **Case** Keys as needed.
4. Press the **Next** Key.
5. Press the **Done** Key to save the changes.
6. Press the **Quit** Key or the **Directory/Log** Key to exit.

**Note:** You can edit the name or number before or after you save to the Directory.

## Delete or edit a Personal Directory entry

To delete a Personal Directory entry:



Delete



Yes



1. Use the **Navigation** Keys to highlight the entry you want to edit or delete.
2. Press the **Delete** Key to delete the currently highlighted entry in your Personal Directory.
3. Press the **Yes** Key to confirm the deletion.

To edit a Personal Directory entry:

Edit



Next



Done



Quit



or

Directory/Log



1. Press the **Edit** Key to change the telephone number or name.
2. Use the **Navigation** Keys to highlight the character you want to change.
3. Use the **dial pad** to enter the desired changes. Refer to "Add a Personal Directory entry" on page 102 for an example of how to use the dial pad to enter names.
4. Press the **Next** Key. Edit the number if necessary.
5. Press the **Done** Key to save the changes.
6. Press the **Quit** Key or the **Directory/Log** Key to exit.

## Delete your Personal Directory

To delete your Personal Directory:

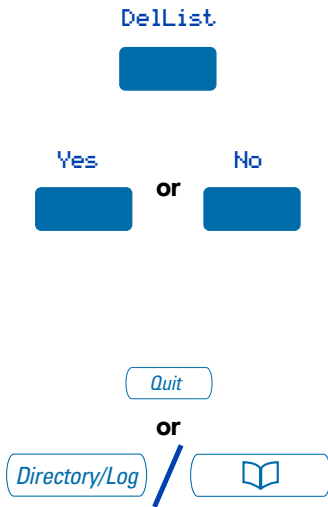

1. Press the **Delete List** Key.  
The display shows Delete all entries?.
2. Press the **Yes** Key if you want to delete all the entries in your Personal Directory, or press the **No** Key if you want to return to the top of the Personal Directory with no changes made.
3. Press the **Quit** Key or the **Directory/Log** Key to exit.

## Use the Personal Directory to make a call

To use the Personal Directory to make a call:

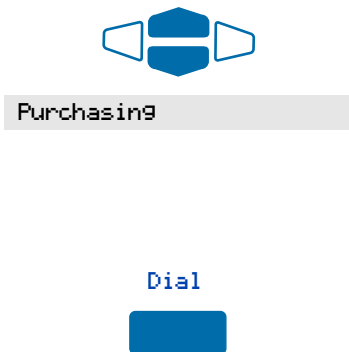

1. Use the **Navigation** Keys to highlight the desired name or number.

**Note:** If you are dialing an external or long distance number, be sure that your directory entry includes the access codes required by your system to make an external or long distance call.

2. Press the **Dial** Key.

**Note:** If your primary DN is busy, the following message will be displayed Unable to Dial - Busy Primary Line. Press the **OK** Key to clear the message. Select an available **DN** Key, and press the **Dial** Key again.

## Use Card View

The **Card View** feature provides additional information about the Personal Directory entry.

**To look at the Card View:**



Purchasing



1. Use the **Navigation** Keys to highlight the desired name.
2. Press the right **Navigation** Key.

**To dial from the Card View:**



Dial



1. Use the **Navigation** Keys to show the name and number of the currently selected entry in the Card View.
2. Press the **Dial** Key to place the call.

**Note:** If you are dialing an external or long distance number, be sure that your directory entry includes the access codes required by your system to make an external or long distance call.

**Note:** If your primary DN is busy, the following message will be displayed **Unable to Dial - Busy Primary Line**. Press the **OK** Key to clear the message. Select an available **DN** Key, and press the **Dial** Key again.

**To exit the Card View:**



Press the left **Navigation** Key to leave the Card View and return to the selected name.

## Search for an entry

You can search for a particular entry in your Personal Directory.

To search for an entry:



Personal Directory

Select



1. Use the **Navigation** Keys to highlight Personal Directory.
2. You may press the **Select** Key or proceed directly to step 3.
3. Use the **dial pad** to enter the first letter of the name you are seeking. For example, press the **2** key twice to go to the first entry that begins with the letter "B".

**Note:** To further refine your search, wait a couple of seconds and use the **dial pad** to enter the second letter of the name you are seeking. You may enter up to the first three letters in the name using this method.

## Copy a number from the Redial List

You can copy a number from the Redial List to the Personal Directory.

To copy a number from the Redial List:



2498



Dirctry



1. Use the **Navigation** Keys to highlight the name or number in your Redial List that you want to copy to your Personal Directory.
2. Press the **Copy** Key.  
The displays shows COPY to.
3. Press the **Directory** Key.

Next



or

Clear



Next



Done



4. Press **Next** to copy the incoming call without editing the name. Edit the number, if required (see notes for step 5), and go to step 6.

or

Press **Clear** to make changes to the name before saving. Add the name using the **dial pad**, **Delete**, and **Case** Keys as needed.

5. Press the **Next** Key. Make changes to the telephone number, if required.

**Note 1:** The number may contain up to 31 digits.

**Note 2:** Press the **Pause** Key to insert a 1.5 second pause in the dialing string.

**Note 3:** If you are copying an external or long distance number, be sure that your directory entry includes the access codes required by your system to make an external or long distance call.

6. Press the **Done** Key. The entry is saved to your Personal Directory and you are returned to the Redial List.

## Set-to-Set Messaging

With the **Set-to-Set Messaging** application activated (available on the **M3903** and **M3904**), an internal caller using an **M3903** or an **M3904** receives a quick visual message, which you have selected, whenever they dial your telephone number. The length of your message is limited to 24 characters. The message is entered through the dial pad keys using a process similar to the one used for entering names in the **M3904**'s Personal Directory. Your network administrator may provide access to a list of up to ten messages which you may customize and select as your current set-to-set message. Only one message at a time may be customized and only one message can be stored.

You can check your Call Log to determine whether or not a caller was sent the set-to-set message. A \* (**M3903**) or (+) (**M3904**) will appear beside the call log entry of the callers who saw your message. **Note:** This feature is not available on the Meridian SL-100.

### To access Set-to-Set Messaging:



Set to Set Messaging

Select



1. Press the **Applications** Key.
2. From the **Applications** menu, use the **Navigation** Keys to highlight **Set to Set Messaging**.
3. Press the **Select** Key.

The **Set-Set Msg** screen appears indicating the status of the feature (on or off) and whether or not a message is stored (defined) in memory.

**Note:** On the **M3904**, if you have activated password protection on your Directory/Log, you will need to enter your password to continue.

### To edit the currently stored message, or to create a new message:

Edit



1. Press the **Edit** Key.



2. From the **Edit Mode** screen, use the **dial pad** to enter a text message. Press the **Delete** Key to delete a character. Press the **Case** Key to toggle between upper and lower case characters. Press the **Cancel** Key to exit the screen without saving changes.

**Note 1:** Please refer to “Add a Personal Directory entry” on page 102 for detailed instructions on using your telephone’s dial pad to enter text.

**Note 2:** While in the **Edit Mode** screen, press the **Up Navigation** Key to access special characters you may want to include in your message. Use the **Navigation** Keys to locate the character. Press the **Select** Key to choose the highlighted character. Press the **Return** Key to return to message entry without selecting a special character.

Done



3. Press the **Done** Key.

Your message is saved and you return to the **Set-Set Msg** Screen.

To select a message provided by your network administrator:



Select



1. From the **Set-Set Msg** screen, use the **Navigation** Keys to scroll through the list of available messages.
2. Press the **Select** Key to choose the currently displayed message.

To customize a message provided by your network administrator:



Edit



1. From the **Set-Set Msg** screen, use the **Navigation** Keys to scroll through the list of available messages.
2. Press the **Edit** Key to choose the currently displayed message.





- From the **Edit Mode** screen, use the **dial pad** to customize the message. Press the **Delete** Key to delete a character. Press the **Case** Key to toggle between upper and lower case characters. Press the **Cancel** Key to exit the screen without saving changes.

**Note 1:** Please refer to “Add a Personal Directory entry” on page 102 for detailed instructions on using your telephone’s dial pad to enter text.

**Note 2:** While in the **Edit Mode** screen, press the **Up Navigation** Key to access special characters you may want to include in your message. Use the **Navigation** Keys to locate the character. Press the **Select** Key to choose the highlighted character. Press the **Return** Key to return to message entry without selecting a special character.

Done



- Press the **Done** Key.

Your message is saved and you return to the **Set-Set Msg** Screen.

**Note:** If you scroll to a different message in the **Set-Set Msg** screen, and press the **Select** Key, your changes are erased.

To activate or deactivate Set-to-Set Messaging and exit the application:



- Press the **On** Key/**Off** Key to toggle the Set-to-Set Messaging status between On and Off.

**Note 1:** If messages have not been provided by your network administrator and a message has not been defined, the **On** and **Off** Keys will not appear. Use the **Edit** Key to enter a message before activating Set-to-Set Messaging.

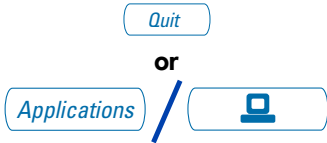

**Note 2:** If messages have been provided by your network administrator, up and down arrows appear on the right side of the display. The **On** and **Off** Keys appear for the most recently selected message.

2. Press the **Quit** Key or the **Applications** Key to exit the **Set-to-Set Messaging** application.

**Note:** If you press the **Quit** Key or the **Applications** Key before you press the **Done** Key, you exit the application without saving your changes.

## Corporate Directory

The **Corporate Directory** application (available on the **M3903** and **M3904**) allows you to search by entering the characters in the name of the person you are calling, beginning with the last name. Once you have located the name and number of the person, you may use the dial soft key to call the number. On the **M3904**, you may copy an entry from the Corporate Directory and paste it into your telephone's Personal Directory for quick access.

**To use the Corporate Directory application:**



Corporate Directory

Select



1. Press the **Applications** Key.

**Note:** If, when you press the **Applications** Key, Corporate Directory is highlighted, you may proceed directly to step 4.

2. From the **Applications** menu, use the **Navigation** Keys to highlight Corporate Directory.
3. Press the **Select** Key.  
The **Corporate Directory Find** screen appears.
4. Use the **dial pad** to enter the name of the person you want to call. Enter the last name first. Separate the last name and first name with a comma.

**Note 1:** The comma is the first character on the **1** Key on your dial pad.

Done



Dial



To find another directory listing or to refine your current directory search:

NewFind



or

Resume



**Note 2:** You do not need to enter the entire name. When the **Done** Key is pressed, the application will highlight the first directory entry that matches the text that you entered.

5. Press the **Done** Key.

The application highlights the first entry that matches the text you entered in step 4. If there is no match, the screen displays **No matches found for . . .** (the text that you entered).

6. Use the **Navigation** Keys to scroll through the directory.

**Note:** The entire directory is available. The “find” process determines which directory entry to select as your starting point.

7. If desired, use the **Right Navigation** Key to move from “list” view to “card” view. In card view, the telephone and department numbers for the entry are viewable. Use the **Left Navigation** Key to return to list view.

**Note:** While you are in card view, you may use the **Up** or **Down Navigation** Key to scroll through directory entries.

8. Press the **Dial** Key to call the person whose name is highlighted.

**Note:** On the Meridian SL-100, if your primary **DN** Key is busy, select an available **DN** Key and then press the **Dial** Key.

Press the **NewFind** Key to begin a new search, or press the **Resume** Key to enter additional characters so that you may narrow your search.

To exit the Corporate Directory application:

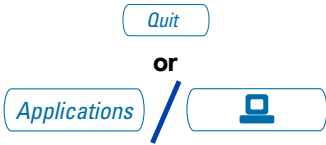

Press the **Quit** Key or the **Applications** Key.

To copy an entry from the Corporate Directory to your telephone's Personal Directory:

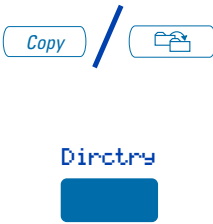

1. With the entry selected in the Corporate Directory, press the **Copy** Key.
2. In the **Copy to** screen, press the **Directory** Key to copy the name and telephone number to your Personal Directory.

After you complete editing and entering the name and telephone number, you are returned to the Corporate Directory.

To transfer a call to a number in the Corporate Directory:

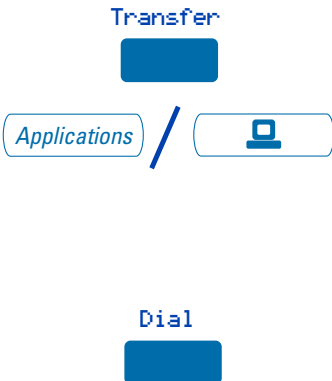

1. Before accessing the Corporate Directory, press the **Transfer** Key.
2. Press the **Applications** Key.  
Follow the steps outlined in "To use the Corporate Directory application:" on page 114 to find the person to whom you want to transfer the call.
3. Press the **Dial** Key to transfer the call to the person whose name is highlighted.

## Virtual Office

The **Virtual Office** feature (available on the **M3903** and **M3904**) allows you to log into a specially designated **M3903** or **M3904** telephone. When you log into the telephone your individual configuration is downloaded to the telephone for line (DN) and feature access. Virtual Office is ideal for use on a telephone which may be assigned to different users depending on the hour-of-the-day or the day-of-the-week.

**To logon to the Virtual Office telephone:**



1. Lift the **handset**.
2. **Dial** the Virtual office Terminal Log oN (**VTLN**) FFC on the Meridian 1 or the Virtual Office Worker IN (**VOWIN**) FAC on the Meridian SL-100.
3. On the Meridian 1, from the **VTN Login** screen, **Enter** your password using the telephone's dial pad.

On the Meridian SL-100, you receive dial tone. **Enter** the **VOW** authorization code, if required on your system; then, after you receive dial tone, **Enter** your personal authorization code.

**Note:** If you make a mistake while entering a code or number on the Meridian SL-100, press the **\*** Key and re-enter the code.

4. On the Meridian 1 you are prompted to **Enter** your User ID. Use the dial pad to **Enter** the primary line (DN) assigned to your Virtual Office telephone.

On the Meridian SL-100, you receive dial tone. Use the dial pad to **Enter** the primary line (DN) for your telephone; then, after you receive dial tone, **Enter** your passcode.

**Note 1:** If your Virtual Office telephone is configured as an **M3903**, you may only login to an **M3903**. If your Virtual Office telephone is configured as an **M3904**, you may only login to an **M3904**.

**Note 2:** If two or more users are attempting to log on at the same moment, the system processes the log on information for the first user. The other user(s) will receive a **System busy, try later.** message. Wait a moment and try to log on again.

To log off the Virtual Office telephone:



or

VTLF FFC



1. Lift the **handset**.
2. **Dial** the Virtual office Terminal Log off (VTLF) FFC on the Meridian 1 or the Virtual Office Worker OUT (VOWOUT) FAC on the Meridian SL-100.

or

If available, **Press** the autodial key which has been configured to dial the VTLF FFC.

**Note 1:** You can not be logged on to more than one Virtual Office telephone at any time.

**Note 2:** Your network administrator determines whether or not your Callers List and Redial List are erased when you log off the Virtual Office telephone. This automatic erase feature is not available on the Meridian SL-100.

## M3901 Feature Operation

**M3901** is a one line telephone. The **M3901** operates in a different way than the other M3900 series Digital Telephones. This section explains in some detail the **M3901** operation.

The **M3901** supports five programmable features. You activate the features when you press the **M3901** Feature Key and a dial pad number key for that feature. Your system administrator programs the features for your telephone. There is a feature card placed on your telephone, which lists the features and instructions.

### M3901 Fixed Keys

#### Goodbye Key

To end a call:



or



Press the **Goodbye** Key to terminate a call.

or

Replace the **handset** to terminate a call.

#### Hold Key

To put a call on Hold:



Press the **Hold** Key to put an active call on hold.

To take a call off Hold:



Press the **Line** (DN) Key to take the call off hold.

**Note:** When a call is on hold, the Message Waiting Call Status Indicator flashes to serve as a reminder.

## Line (DN) Key

To use the Line (DN) Key to make a call:



or



1. Press the **Line** (DN) Key.

or

Lift the **handset**. The Line (DN) Key is automatically selected.

2. **Dial** the telephone number.

## Volume Control Bar

Use the **Volume Control Bar** to raise or lower the volume on the ringer or handset.

To adjust the ringer volume:



While the telephone is ringing, press the right side of the **Volume Control Bar** to raise the ringer volume or press the left side of the **Volume Control Bar** to lower the ringer volume.

To adjust the handset volume (voice or dial tone):



With sound coming from the handset, press the right side of the **Volume Control Bar** to raise the handset volume or press the left side of the **Volume Control Bar** to lower the handset volume.

## Features Key

To activate a feature:



1. Press the **Features** Key.
2. Press the **Dial Pad Number** Key assigned to the feature you want to use.



## Program a feature or an Auto Dial

Your network administrator may configure up to five features for your telephone. The Features Card on the right side of the M3901 lists each feature and the Dial Pad Number Key used to activate the feature.

After you press the Feature Key, you have 30 seconds to press a Dial Pad Number Key or the process ends.

### To activate a feature:



1. Press the **Features** Key.
2. Press the **Dial Pad Number** Key assigned to the feature you want to use.

### To deactivate the active feature:



1. Press the **Features** Key.
2. Press the **#** Key.

### To program an Auto Dial Key:



1. Without lifting the handset, press the **Features** Key.
2. Press the **Dial Pad Number** Key for the Auto Dial position you want to program. The Feature Activation Indicator flashes.
3. **Dial** the number you want to program to the Auto Dial position.
4. Press the **Features** Key.
5. Press the **Dial Pad Number** Key for the Auto Dial position you just programmed.

## Use Auto Dial

**Auto Dial** lets you dedicate a feature position to a specific telephone number. When the Features Key and assigned Dial Pad Number Key are pressed, the number is dialed automatically. This feature must be enabled by your network administrator.

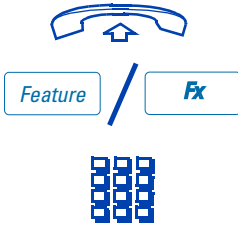

1. Lift the **handset**.
2. Press the **Features** Key.
3. Press the **Dial Pad Number** Key for the Auto Dial position assigned to the number you want to call.  
The number dials automatically.

## Use Speed Call

The **Speed Call** feature allows you to automatically dial frequently called numbers by entering a one, two, or three digit code. Contact your network administrator to determine the capacity of your Speed Call list.

A telephone designated as a Speed Call Controller can program or edit the Speed Call list. This feature must be enabled by your network administrator.

**To store a Speed Call Entry:**

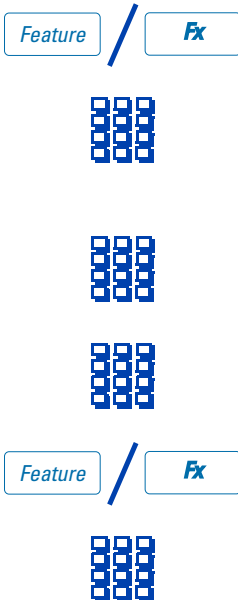

1. Without lifting the handset, press the **Features** Key.
2. Press the **Dial Pad Number** Key assigned to the Speed Call Controller feature. The Feature Activation Indicator flashes.
3. **Dial** a 1 to 3 digit Speed Call code (ask your network administrator for the number of digits required.)
4. **Dial** the number you want to program to the Speed Call code entered in the previous step.
5. Press the **Features** Key.
6. Press the **Dial Pad Number** Key for the Speed Call Controller feature.

### To make a Speed Call:

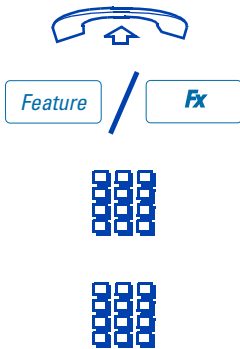

1. Lift the **handset**.
2. Press the **Features** Key.
3. Press the **Dial Pad Number** Key for the Speed Call Controller feature or the Speed Call User feature.
4. **Dial** the Speed Call code of the number you want to call.

The Speed Call feature automatically dials the number.

### Use Call Transfer

Use the **Transfer** feature to redirect a call to a third party.

#### To use the Transfer feature:

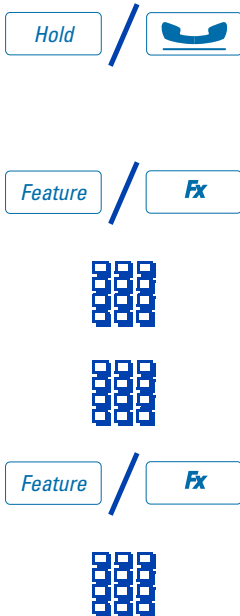

1. Press the **Hold** Key to put the active call on hold.
- Note:** The previous step is not required if the Automatic Hold feature is active.
2. Press the **Features** Key.
3. Press the **Dial Pad Number** Key for the Transfer feature.
4. **Dial** the number where you want to transfer the call.
5. Press the **Features** Key when you hear ringing tone.
6. Press the **Dial Pad Number** Key for the Transfer feature.

**Note:** On the Meridian SL-100 use steps one to three then hang up. If you continue, a three way conversation is established.

## Set up a Conference call

You can set up a **Conference** call for up to six people (including yourself). Contact your network administrator to determine the maximum number of people your system allows on a conference call.

**To use the Conference Call feature:**



1. Press the **Hold** Key to put the active call on hold.

**Note:** The previous step is not required if the Automatic Hold feature is active.



2. Press the **Features** Key.



3. Press the **Dial Pad Number** Key for the Conference feature.



4. **Dial** the number of the party you want to add to the call.



5. Press the **Features** Key.



6. Press the **Dial Pad Number** Key for the Conference feature.

**Note 1:** Repeat these step to add more parties to the conference (up to six).

**Note 2:** Press the **Goodbye** Key, if you make an error while dialing the number or if you receive a busy signal.

**To return to the original caller:**



Press the **Line (DN)** Key.

## Activate Ring Again

Use the **Ring Again** feature when you dial a number and receive a busy tone or no answer. The Ring Again feature lets you know when the person you dialed is available or has used their telephone. The feature notifies you when to redial your party. The Ring Again feature automatically redials the number.

To activate the Ring Again feature:



To use Ring Again to call your party when you receive notification:



To cancel the Ring Again feature:



1. **Dial** a number and receive a busy tone or no answer.

**Note:** The Meridian SL-100 supports Ring Again on busy tone only.

2. Press the **Features** Key.
3. Press the **Dial Pad Number** Key for the Ring Again feature.
4. Replace the **handset**.

1. Lift the **handset**.
2. Press the **Features** Key.
3. Press the **Dial Pad Number** Key for the Ring Again feature. Ring Again dials the number.

1. Press the **Features** Key.
2. Press the **Dial Pad Number** Key for the Ring Again feature before you hear the Ring Again notification tone.

## Make a call

---

To dial a number while on-hook:



1. Press the **Line** (DN) Key.
2. **Dial** the number.
3. Lift the **handset** and speak when the party answers.

To use handset and dial number:



1. Lift the **handset**, the telephone automatically selects the Line (DN).
2. **Dial** the telephone number.

## Receive a call

---

To receive a call:



Lift the **handset** when the telephone rings and begin to talk.

## Feature Activation Indicator

---

The Feature Activation Indicator (FAI) serves all five programmable feature keys. The feature indicator LED winks or lights when a feature is active.

## Message Waiting and Call Status Indicator

---

The Message Waiting Indicator (MWI) provides three functions. the MWI flashes for an incoming call, the MWI also flashes to indicate a call on Hold. The MWI produces a steady light to indicate that a message is waiting. The MWI cannot show there is a message waiting if a call is on hold or if there is an incoming call.

## Accessories for the M3900 Series telephones

Optional items are available for use with your M3900 Series Digital telephone. Please contact your System Administrator for additional details.

**Note:** Wall attachment is available for all four models.

### Accessory Connection Module (ACM)

---

The **Accessory Connection Module (ACM)** provides the interface for adding the Analog Terminal Adapter, External Alerter and Recorder Interface, Computer Telephony Integration Adapter, and Personal Directory PC Utility Cartridge. The ACM is available for the **M3902**, **M3903** and **M3904**.

### Analog Terminal Adapter (ATA)

---

The **Analog Terminal Adapter (ATA)** allows you to connect an analog device such as a modem or fax machine to your telephone. The ATA is available for the **M3902**, **M3903**, and **M3904** models.

### Computer Telephony Integration Adapter (CTIA)

---

The **Computer Telephony Integration Adapter (CTIA)** provides an interface between M3900 Series telephones (**M3902**, **M3903**, and **M3904**) and your PC for first party call control applications. The CTIA also functions as a Personal Directory PC Utility Cartridge when used with the optional Personal Directory PC Utility software. This accessory is not supported on the Meridian SL-100.

### Display-based Expansion Module

---

The **Display-based Expansion Module** provides additional line (DN) or feature keys for the **M3904**. The Display-based Expansion Module has eight keys on three different layers for a total of 24 additional line (DN) or feature keys. The three layers are accessed through the use of a "page" key. The **M3904** will support one Display-based Expansion Module.

### External Alerter and Recorder Interface

---

The **External Alerter and Recorder Interface** lets you connect a remote ringer to your telephone. The External Alerter and Recorder interface is available for the **M3902**, **M3903**, and **M3904** models.

## Full Duplex Hands Free Module

---

The **Full Duplex Hands Free Module** provides simultaneous audio paths for transmitting and receiving during hands free calls. The Full Duplex Handsfree Module is available for the **M3904**.

## Headsets

---

Amplified headsets are compatible with your M3900 Series Meridian Digital Telephone. The amplified headset is an option for noisy environments. An amplified headset should be connected to the handset jack. The Headset Key is not able to control a headset that is connected to the handset jack. In this configuration, do not select Headset as the On hook default path.

For an amplified headset, adjust the volume using the **Volume Control Bar** on your telephone before adjusting the volume on your headset amplifier. To minimize distortion, the volume setting on the amplifier should be higher than the volume setting on the telephone.

Unamplified headsets are compatible with the **M3903** and **M3904**. An unamplified headset should be plugged into the headset jack. With Headset selected as the On hook default path, you can make calls or answer incoming calls by pressing a **DN** Key.

For an unamplified headset, access Volume Adjustment in the Options List to adjust the headset volume and sidetone (**M3904**) that work best with the headset you are using. You may also use the **Volume Control Bar** to adjust the headset volume while you are on a call. Refer to your distributor for the latest product bulletin from Nortel Networks for recommended headset types for the M3900 Series telephones.

## Key-based Expansion Module

---

The **Key-based Expansion Module** provides additional line (DN) or feature keys for the **M3904**. You can add up to two Key-based Expansion Modules, for a total of 44 additional line (DN) or feature keys.

## Personal Directory PC Utility

---

The **Personal Directory PC Utility** provides a faster, easier way to create or modify the Personal Directory on the **M3904**. You can enter names and numbers into a directory file on your PC, and download the file directly from the PC to the **M3904** through a serial port connection. You can also upload the Personal Directory from the **M3904** to your PC so that you can modify the directory. The PC and the **M3904** are connected using the Personal Directory PC Utility Cartridge. The Computer Telephony Integration Adapter (CTIA) may also be used to connect the PC and the **M3904** when used with the optional Personal Directory PC Utility software.



## Meridian 1 Flexible Feature Codes (FFCs)

	Call Detail Recording Charge Account		Make Set Busy Deactivate
	Call Forward All Calls Activate		Malicious Call Trace
	Call Forward All Calls Deactivate		Override
	Call Forward All Calls Verify		Radio Paging
	Internal Call Forward Activate		Radio Paging Access
	Internal Call Forward Deactivate		Radio Paging Answer
	Remote Call Forward Activate		Ring Again Activate
	Remote Call Forward Deactivate		Ring Again Deactivate
	Park Call		Speed Call Controller
	Park Call Access		Speed Call User
	Pickup Ringing Number		System Speed Call User
	Pickup Group		Station Control Password Change
	Pickup Directory Number		Virtual Office Terminal Log On
	Electronic Lock Activate		Virtual Office Terminal Log Off
	Electronic Lock Deactivate		Automatic Wake-Up Activate
	Group Call		Automatic Wake-Up Deactivate
	Make Set Busy Activate		Automatic Wake-Up Verify

## Meridian SL-100 Feature Access Codes (FACs)

	Account Code		Last Number Redial
	Anonymous Caller Rejection (ACRJ) Activate		Malicious Call Hold (MCH)
	Anonymous Caller Rejection (ACRJ) Deactivate		Paging access code
	Automatic Callback (ACB) Activate		Random Make Busy (RMB)
	Automatic Callback (ACB) Deactivate		Secondary MADN Call Forwarding (CFMDN)
	Automatic Recall (AR) Activate		Selective Call Forward (SCF)
	Automatic Recall (AR) Deactivate		SIM Ring
	Busy Override		System Call Park
	Call Forward Busy/Don't Answer - Internal/External		Station Origination Restrictions Controller (SORC)
	Calling Name and Number Delivery Blocking		Station Specific AuthCode (SSAC)
	Customer Originated Trace (COT)		Uniform Call Distribution (UCD)
	Directed Call Park (DCPK)		Virtual Office Worker IN (VOWIN)
	Directed Call Pick-up (DCPU)		Virtual Office Worker OUT (VOWOUT)
	Executive Busy Override (EBO)		Wake-Up Request
	Flexible Station Controlled Conference (CNF)		Wake-Up Cancel

**A**

- access the Personal Directory **102**
- Accessory Connection Module (ACM) **127**
- account code **54, 56**
- Analog Terminal Adapter (ATA) **127**
- announcement **53, 65**
- Anonymous Caller Rejection **72**
- answer calls **24**
- applications
  - Corporate Directory **114**
  - Set-to-Set Messaging **111**
- Applications Key **6**
- area code setup **86**
- attendant **8**
- Attendant Recall **28**
- Auto Dial **16, 121, 122**
  - display number **16**
- Auto Dial Transfer **52**
- Automatic Answerback **36**
- Automatic Callback **73**
- Automatic Hold **123, 124**
- Automatic Recall **74**
- Automatic Wake-Up **67**

**B**

- busy **51**
- Busy Override **61**
- buzz **52**

**C**

- call accounting **33**
- Call Charge
  - M3902 **54**
  - M3903, M3904 **56**
- Call Detail Recording Charge Account **54, 55**
- Call Forward
  - Internal **41**
  - M3902 **39**
  - M3903, M3904 **40**
  - Remote **42**
  - Selective **76**
- call hold **25**
- call indicator light **88**

- Call Join
  - M3902 **47**
  - M3903, M3904 **47**
- Call Log **8, 97**
  - access, M3904 **93**
- Call Log Key **6, 94, 95**
- Call Log options **85**
- Call Page **53**
- Call Park **29**
  - M3902 **28**
  - M3903, M3904 **30**
- Call Party Name Display (CPND) **8**
- Call Pickup **37**
- call status indication
  - M3901 **126**
- call timer **87**
- Call Trace **35**
- call transfer
  - M3901 **123**
  - M3902 **25**
  - M3903, M3904 **26**
- Call Waiting **38**
- Callers List **97**
  - M3903 **97**
  - M3904 **98**
- Calling Name and Number Delivery Blocking **76**
- Calling Party Number
  - M3902 **33**
  - M3903, M3904 **33**
- camp-on
  - forced **58, 59**
  - station **60**
- Card View **108**
- card view **8**
- Centrex Switchhook Flash **53**
- Centrex/Exchange Switchhook Flash **53**
- charge account **33, 55**
- Charge Account, Forced
  - M3902 **54**
  - M3903, M3904 **56**
- charge calls

- M3902 **54**
- M3903, M3904 **56**
- Computer Telephony Integration
  - Adapter (CTIA) **127, 128**
  - Conference **35, 48, 124**
  - M3902 **45**
  - M3903, M3904 **46**
  - Context Sensitive Soft Keys **3, 4, 8**
  - copy from Redial List **109**
  - Copy Key **6, 8**
  - Corporate Directory **114**
  - Customer Originated Trace **75**
- D**
- date format **87**
- Date/time display **8**
- Dial Key **7**
- Dial Tone
  - interrupted **8**
- dial tone, special **9**
- dialing
  - on-hook **14, 16**
  - predial **14**
- Direct Inward System Access **42, 43**
- Directed **29**
- Directed Call Park (DCPK) Key **29**
- directory **92**
  - password protection **94**
- Directory Number (DN) **8, 69, 71**
- Directory Number (DN) Key **6, 7**
- Directory/Log Key **6, 93, 94, 95, 96, 102**
- display
  - M3902 **77**
  - M3903 **77**
  - M3904 **78**
- display diagnostics **89**
- Display Key **34**
- Display-based Expansion Module **127**
- DN **8**
- Done Key **6, 79**
- E**
- Electronic Lock **44**
- Enhanced Override **58**
- External Alerter and Recorder Interface **127**
- F**
- Feature Access Code (FAC) **8, 10, 29, 30, 35, 37, 39, 41, 42, 61, 63, 67, 72, 73, 74, 75, 76, 117, 118, 130**
- Feature Activation Indicator (FAI), M3901 **126**
- feature key
  - change label (M3902) **80**
  - change label (M3903, M3904) **82**
- feature operation
  - M3901 **119**
- Features Key, M3901 **120**
- Fixed Keys **8**
- Flexible Feature Code (FFC) **8, 10, 20, 22, 29, 30, 35, 37, 39, 41, 42, 43, 44, 49, 51, 54, 55, 58, 61, 63, 67, 117, 118, 129**
- Forced Camp-on **58, 59**
- forward calls
  - all calls
    - M3902 **39**
    - M3903, M3904 **40**
  - internal calls **41**
  - remote activation **42**
  - selective **76**
- Full Duplex Hands Free Module **128**
- G**
- Goodbye Key **5, 10, 119**
- Group Call **49**
- Group Intercom **65**
- Group Listening **12**
- group listening **90**
- H**
- handsfree **5, 10**
- Handsfree Key **5, 10**
- Headset Key **5, 11**
- headset port external alerter **88**
- headset port on call **88**
- headsets **128**
- Hold **25, 38**
- Hold Key **5, 119**

hook switch **9**  
 Hospitality features **67**  
 Hot Line **22**

**I**

indicator **8**  
 Information display **8**  
 Information line **8**  
 Intercom **23**  
 Internal Call Forward **41**  
 Interrupted dial tone **8**

**J**

join a call  
   M3902 **47**  
   M3903, M3904 **47**

**K**

key click **87**  
 key layout  
   M3901 **1**  
   M3902 **2**  
   M3903 **3**  
   M3904 **4**  
 Key-based Expansion Module **128**  
 keys

  Applications Key **6**  
   Call Log **6**  
   Call Log Key **94, 95**  
   Copy Key **6, 8**  
   Dial Key **7**  
   Directory/Log Key **6, 93, 94, 95, 96, 102**  
   Display Key **34**  
   Done Key **6, 79**  
   Feature Key **80, 82**  
   Features Key, M3901 **120**  
   Fixed Keys **8**  
   Goodbye Key **5, 10, 119**  
   Handsfree Key **5, 10**  
   Headset Key **5, 11**  
   Hold Key **5, 119**  
   Line (DN) Key **5, 6, 7**  
   Line (DN) Key, M3901 **120**  
   M3901 keys **119**  
   Message Key **6**

  More... Key **7, 9**  
   Mute Key **5, 10**  
   Navigation Keys **6, 79**  
   Options Key **6, 79**  
   Primary Directory Number (PDN) Key **7**  
   Programmable Line (DN)/Feature Key **7, 82**  
   Programmable Soft Keys **7**  
   Quit Key **6, 79**  
   Select Key **79**  
   Shift Key **6**  
   Volume Control Bar **5, 120**

**L**

language selection **80**  
 Last Number Redial **19**  
 Line (DN) Key **1, 2, 5, 35, 120**  
 Line Key **6, 7**  
 live dial pad **86**

**M**

M3901  
   feature operation **119**  
   fixed keys **119**  
   key layout **1**  
 M3901 Features  
   Auto Dial **121, 122**  
   call status indication **126**  
   Call Transfer **123**  
   Conference **124**  
   Feature Activation Indicator (FAI) **126**  
   make a call **126**  
   Message Waiting Indicator (MWI) **126**  
   receive calls **126**  
   Ring Again **125**  
   Speed Call **122**  
 M3902  
   display **77**  
   key layout **2**  
   Options List **79**  
 M3903  
   Callers List **97**

- display **77**
- key layout **3**
- Options List **79**
- Redial List **100**
- M3904
  - Callers List **98**
  - Directories **92**
  - display **78**
  - key layout **4**
  - Options List **79**
  - Personal Directory **102**
  - Personal Directory, access **93**
  - Redial List **101, 109**
- Maid Identification **70**
- make a call
  - M3901 **126**
- Make Set Busy **51**
- Malicious Call Hold (MCH) **35**
- Malicious Call Trace **35**
- Meridian **1 9**
- Meridian SL-100 **8, 9, 10, 16, 17, 19, 22, 25, 26, 27, 28, 29, 34, 35, 41, 42, 49, 54, 56, 59, 63, 65, 67, 117, 123, 125**
- Message Key **6**
- Message Registration **69**
- Message Waiting Indicator (MWI), M3901 **126**
- More... Key **7, 9**
- Multiple Appearance Directory Number (MADN) **9, 62**
- mute **10**
- Mute Key **5, 10**
- N**
- Navigation Keys **6, 79**
- O**
- off-hook **9**
- on-hook default path **89**
- on-hook dialing **14, 16**
- Options Key **6, 79**
- Options List **79**
- Override **58, 61**
- override
  - enhanced **58**
- P**
- page **53**
- “Meet - me” page **63**
- paging **63**
- paging tone **9**
- park
  - M3902 **28**
  - M3903, M3904 **30**
- password
  - directory **94**
- password change **44**
- Personal Directory **9, 94, 102, 109**
  - add an entry **102**
  - Card View **108**
  - delete directory **107**
  - delete entries **106**
  - edit entries **106**
  - make calls from directory **107**
  - search **109**
- Personal Directory PC Utility **127, 128**
- pickup **37**
- Predial **14**
- preferred name match **86**
- Preset Conference **49**
- Primary Directory Number (PDN) **7, 9**
- Privacy Release **62**
- Private Line **9**
- Programmable Line (DN)/Feature Key **3, 4, 7, 82, 83**
- Programmable Soft Keys **2, 7**
- Q**
- Quit Key **6, 79**
- R**
- Radio Paging **63**
- recall
  - attendant **28**
  - Timed Reminder Recall **27**
- receive calls
  - M3901 **126**
  - M3902, M3903, M3904 **24**
- Redial **19**
- Redial List **9, 97, 100, 109**

- access, M3904 **93**
- M3903 **100**
- M3904 **101**
- Remote Access Directory Number **42**
- Remote Call Forward **42**
- Ring Again
  - M3901 **125**
  - M3902 **17**
  - M3903, M3904 **18**
- ring tone **9, 59, 60**
- ring type **85**
- ringback **9, 59, 60**
- Room Status **71**
- S**
- screen contrast **84**
- secure your telephone **44**
- Select Key **79**
- Selectable Conferee Display and Disconnect **48**
- Selective Call Forward **76**
- Set-to-Set Messaging **111**
- shared Directory Number (DN) **9**
- Shift Key **6**
- special characters, entering **81, 83, 103, 112, 113**
- special dial tone **8, 9**
- Speed Call **122**
  - M3902 **20**
  - M3903, M3904 **21**
- Speed Call Controller **123**
  - M3902 **20**
  - M3903, M3904 **21**
- Speed Call User **123**
- Speed Call, System **22**
- Station Camp-on **60**
- Station Control Password **42, 43, 44**
- switch hook **9**
- System Park DN **29**
- System Speed Call **22**
- T**
- time
  - format **87**
  - wake-up, automatic **67**
- Timed Reminder Recall **27**
- trace **35**
- Transfer **35, 54, 123**
  - M3902 **25**
  - M3903, M3904 **26**
- V**
- Virtual Office **117**
- Vmsg **65**
- Voice Call **65**
- Voice Messaging control **65**
- Volume Control Bar **5, 120**
- volume, adjust **84**
- VOWIN **117**
- VOWOUT **118**
- VTLF **118**
- VTLN **117**
- W**
- work without interruption **51**







Title to and ownership of Meridian SL-1 software shall at all times remain with Nortel Networks. Meridian SL-1 software shall not be sold outright and the use thereof by the customer shall be subject to the parties entering into software agreements as specified by Nortel Networks.

Information contained in this document is subject to change. Nortel Networks reserves the right, without notice, to make changes in equipment design or program components as progress in engineering, manufacturing or technology may warrant.

Reordering number: NT2F79EB A0858904  
(c/o 5 each per package P0942070)

Internal Manufacturing part number:

P0942070

Issue 1.00

January 2002

Printed in Canada

[www.nortelnetworks.com](http://www.nortelnetworks.com)

**NORTEL**  
NETWORKS